



Federal Republic of Nigeria

Federal Ministry of Works

Highway Manual Part 1: Design

Volume VI:
Road Traffic Signs and Road Markings

2013

FOREWORD

The vision statement of the Federal Ministry of Works is to elevate Nigerian roads to a standard where they become National economic and socio-political assets, contributing to the Nation's rapid growth and development, and to make Federal roads functional, safe, pleasurable, and an avenue for redeeming Nigerians' trust and confidence in Government. This vision statement is in tune with the Transformation Agenda of the President of the Federal Republic of Nigeria, His Excellency, Dr Goodluck Ebele Jonathan, GCFR. Based on the foregoing, our mission is to use the intellectual, management and material resources available to the Ministry to make Nigerian roads functional all the time. The principal goal of the Ministry is to drive the transformation agenda by improving road transport infrastructure for the overall socio-economic derivable benefits and development of our great country, Nigeria.

In exercising this mission and in discharging its responsibilities, the Ministry identified the need for updated and locally relevant standards for the planning, design, construction, maintenance and operation of our roads, in a sustainable manner. One of the main reference documents for this purpose is the Highway Manual, which previously included Part 1: Design and Part 2: Maintenance. Both current parts of the Highway Manual were first published in 1973 and 1980 respectively and have been subjected to partial updating at various times since then. The passage of time, development in technology, and a need to capture locally relevant experience and information, in the context of global best practices, means that a comprehensive update is now warranted.

The purpose of the Highway Manual is to establish the policy of the Government of the Federal Republic of Nigeria with regard to the development and operation of roads, at the Federal, State and Local Government levels, respectively. In line with this objective, the Manual aims to guide members of staff of the Ministry and engineering practitioners, with regard to standards and procedures that the Government deem acceptable; to direct practitioners to other reference documents of established practice where the scope of the Manual is exceeded; to provide a nationally recognized standard reference document; and to provide a ready source of good practice for the development and operation of roads in a cost effective and environmentally sustainable manner.

The major benefits to be gained in applying the content of the Highway Manual include harmonization of professional practice and ensuring uniform application of appropriate levels of safety, health, economy and sustainability, with due consideration to the objective conditions and needs of our country.

The Manual has been expanded to include an overarching Code of Procedure and a series of Volumes within each Part that cover the various aspects of development and operation of highways. By their very nature, the Manual will require periodic updating from time to time, arising from the dynamic nature of technological development and changes in the field of Highway Engineering.

The Ministry therefore welcomes comments and suggestions from concerned bodies, groups or individuals, on all aspects of the document during the course of its implementation and use. All feedback received will be carefully reviewed by professional experts with a view to possible incorporation of amendments in future editions.

A handwritten signature in red ink, appearing to read 'Mike Oziegbe', is centered on the page.

Arc. Mike Oziegbe Onolememen, FNIA, FNIM.

Honourable Minister

Federal Ministry of Works,

Abuja, Nigeria

May, 2013

ACKNOWLEDGEMENTS

The Highway Manual has been updated by the Road Sector Development Team (RSDT), of the Federal Ministry of Works, with credit assistance from the World Bank's Federal Roads Development Project (FRDP). This update draws upon the original Manual, which was compiled between 1973 and 1980. The new Manual reflects recent developments in Road Design and Maintenance, in addition to latest research findings and updated references. Furthermore, it includes accepted practices that have been developed with the extensive effort of numerous organisations and people involved in the road sector. The assistance of all who have contributed is hereby gratefully acknowledged. Special acknowledgement is due to the following persons, who have been particularly involved and provided specific input that has been incorporated into the Manual:

Review Project Management Team:

Person

Engr. Ishaq D. Mohammed
Engr. Chike Ngwuocha

Organisation

Director Highways/Unit Manager, RSDT
Highway Engineer, RSDT

Peer Review Group:

Person

Engr. B Giwa
Prof. Y. A Jimoh
Prof. K. J. Osinubi
Prof. L. Oyebande
Dr. D. O. A. Osula

Organisation

Independent Consultant
University of Ilorin
Ahmadu Bello University, Zaria
University of Lagos
University of Benin

Thanks are also due to the following organisations that made staff available for the Stakeholder Workshop and other meetings, in addition to making direct contributions through comments and advice:

Public Organisations

Federal Ministry of Works – Highway Departments
Federal Ministry of Environment
Federal Roads Maintenance Agency (FERMA)
Federal Capital Development Authority
Federal Road Safety Corps

Nigeria Meteorological Agency
Nigerian Geological Survey Agency
Nigeria Police Force (Traffic Division)
Nigeria Hydrological Services Agency
Nigerian Meteorological Agency
Nigerian Society of Engineers
Nigerian Institute of Civil Engineers
Council for the Regulation of Engineering in Nigeria

Private Organisations

AIM Consultants
Aurecon Nigeria Ltd
Axion Consult Engineering Resources Ltd
Ben Mose & Partners
Dantata & Sawoe Construction (Nigeria) Ltd
Enerco Ltd
Etteh Aro & Partners
FA Consulting Services Ltd
Intecon Partnership Ltd
Julius Berger Nigeria Plc
Keeman Ltd
Multiple Development Services Ltd
Mansion Consulting Ltd

Property Mart Ltd
RCC Ltd
Sanol Engineering Consultants Ltd
Setraco Nigeria Ltd
Siraj International Ltd
Yolas Consultants Ltd

This update of the Highway Manual was compiled by the Road Sector Development Team of the Federal Ministry of Works with the assistance of the consultants Royal HaskoningDHV.

Table of Contents

TABLE OF CONTENTS	I
TABLE OF FIGURES	IV
LIST OF TABLES	V
1 GENERAL PRINCIPLES	1-1
1.1 DESCRIPTION OF THE HIGHWAY MANUAL	1-1
1.1.1 <i>Introduction to the Manual</i>	1-1
1.1.2 <i>Arrangement of the Manual</i>	1-1
1.2 OVERVIEW OF VOLUME VI.....	1-1
1.3 ROAD SIGNS AND MARKINGS	1-3
1.4 INTERNATIONAL ROAD SIGNS AND MARKINGS	1-5
1.5 REQUIREMENTS AND PRINCIPLES FOR TRAFFIC SIGNS AND ROAD MARKINGS	1-5
1.6 CLASSIFICATION OF ROADS, TRAFFIC SIGNS AND ROAD MARKINGS	1-7
2 TRAFFIC SIGNS	2-1
2.1 REGULATORY SIGNS (PROHIBITORY).....	2-1
2.2 REGULATORY SIGNS (MANDATORY).....	2-12
2.3 WARNING SIGNS.....	2-22
2.4 INFORMATION SIGNS	2-39
2.5 TEMPORARY ROAD SIGNS	2-48
3 ROAD MARKINGS	3-1
3.1 INTRODUCTION.....	3-1
3.2 STOP AND YIELD MARKINGS.....	3-2
3.2.1 <i>Stop Lines</i>	3-2
3.2.2 <i>Yield Line (Give Way Line)</i>	3-3
3.3 LONGITUDINAL MARKINGS.....	3-4
3.3.1 <i>Dividing Lines (Centre Line)</i>	3-4
3.3.2 <i>Traffic Lane Lines</i>	3-6
3.3.3 <i>Continuity Line (Warning Line)</i>	3-7
3.3.4 <i>Edge of Carriageway Lines</i>	3-8
3.3.5 <i>Painted Traffic Islands</i>	3-9
3.3.6 <i>Exclusive Use Lane</i>	3-11
3.4 DOUBLE WHITE LINES.....	3-11
3.4.1 <i>No Overtaking Lines</i>	3-11

3.4.2	<i>No Crossing Line</i>	3-16
3.4.3	<i>Channelizing Line</i>	3-17
3.5	OTHER DELINEATION DEVICES	3-20
3.5.1	<i>Road studs (“Cats Eyes”)</i>	3-20
3.5.2	<i>Guardrail (Crash barrier) Delineators</i>	3-21
3.6	INTERSECTIONS	3-21
3.6.1	<i>Guide Lines</i>	3-21
3.6.2	<i>Traffic Circle Arrows</i>	3-22
3.7	DIRECTION ARROWS AND LANE DESTINATIONS	3-22
3.7.1	<i>Direction Arrows</i>	3-22
3.8	WARNING MARKINGS	3-24
3.8.1	<i>Word Markings</i>	3-24
3.9	PEDESTRIAN CROSSINGS	3-25
3.9.1	<i>Pedestrian Crossings</i>	3-25
3.10	PARKING	3-26
3.10.1	<i>Parking Bays</i>	3-27
4	TRAFFIC SIGNALS	4-1
4.1	INTRODUCTION	4-1
4.2	WARRANTS FOR TRAFFIC SIGNALS	4-3
4.3	VEHICLE SIGNAL INDICATIONS.....	4-6
4.3.1	<i>Red Light Signals</i>	4-6
4.3.2	<i>Yellow Light Signals</i>	4-6
4.3.3	<i>Green Light Signals</i>	4-7
4.3.4	<i>Yellow and Red Light Signals Shown Together</i>	4-7
4.3.5	<i>Flashing or other Modes of Operation</i>	4-8
4.3.6	<i>Arrangement of Light Signals</i>	4-8
4.3.7	<i>Pedestrian and Pedal Cyclist Signals</i>	4-10
4.4	LOCATION AND VISIBILITY OF TRAFFIC SIGNALS	4-10
4.4.1	<i>Number and Location of Traffic Signal Faces</i>	4-11
4.4.2	<i>Visibility and Mounting of Traffic Signal Faces</i>	4-12
4.5	TRAFFIC SIGNAL TIMINGS AND PHASING	4-18
5	APPLICATION OF TRAFFIC SIGNALS, ROAD MARKINGS AND SIGNALS	5-1
5.1	LONGITUDINAL PLACEMENT	5-1
5.1.1	<i>Longitudinal Placement of Regulatory and Warning Signs</i>	5-1
5.1.2	<i>Longitudinal Placement of Information Signs</i>	5-2
5.2	LATERAL AND VERTICAL PLACEMENT	5-11

5.2.1	<i>Lateral Placement</i>	5-11
5.2.2	<i>Vertical Placement</i>	5-16
5.3	SIZES AND DESIGN OF REGULATORY AND WARNING SIGNS	5-19
5.4	DESIGN OF INFORMATION SIGNS	5-21
5.5	TYPICAL APPLICATIONS AT INTERSECTIONS	5-28
5.6	CHECKLIST FOR ROAD DESIGN - TRAFFIC SIGNS AND MARKINGS DRAWINGS	5-35
6	MATERIALS AND INSTALLATION	6-1
6.1	TRAFFIC SIGN MATERIALS	6-1
6.2	ROAD MARKING MATERIALS	6-2
6.3	INSTALLATION OF ROAD SIGNS	6-3
7	BIBLIOGRAPHY	7-1

List of Figures

FIGURE 1.1: ARRANGEMENT OF HIGHWAY MANUAL	1-2
FIGURE 1.2: SIGNS CLASSIFICATION	1-10
FIGURE 3.2: YIELD LINE	3-3
FIGURE 3.3: YIELD MARKING.....	3-4
FIGURE 3.5: TRAFFIC LANE LINES.....	3-7
FIGURE 3.6: CONTINUITY LINE	3-8
FIGURE 3.7: LEFT EDGE / RIGHT EDGE LINES	3-9
FIGURE 3.8: PAINTED ISLAND	3-10
FIGURE 3.9: EXCLUSIVE LANE	3-11
FIGURE 3.10: NO OVERTAKING LINES FOR VERTICAL CURVES	3-14
FIGURE 3.11: NO OVERTAKING LINES FOR HORIZONTAL CURVES.....	3-15
FIGURE 3.12: NO OVERTAKING LINE.....	3-16
FIGURE 3.13: NO CROSSING LINE.....	3-17
FIGURE 3.14: CHANNELIZING LINE.....	3-18
FIGURE 3.15: TYPICAL CHANNELIZING LINE AT AN EXIT RAMP	3-19
FIGURE 3.16: GUIDE LINES	3-22
FIGURE 3.17: ARROW MARKING TEMPLATE.....	3-24
FIGURE 3.18: TEMPLATE FOR WORD MARKING	3-25
FIGURE 3.19: PEDESTRIAN CROSSING.....	3-26
FIGURE 3.20: PARKING BAYS.....	3-27
FIGURE 4.1: NIGERIAN TRAFFIC LIGHT SYSTEM	4-6
FIGURE 4.2: EXAMPLE OF STEADY ARROW SIGNALS	4-7
FIGURE 4.3: STANDARD SIGNAL FACE.....	4-9
FIGURE 4.4: SIGNAL FACE WITH ARROWS	4-9
FIGURE 4.5: SIGNAL GROUPS	4-10
FIGURE 4.6: STANDARD POST MOUNTING	4-14
FIGURE 4.7: EXTENDED POST MOUNTING.....	4-15
FIGURE 4.8: OVERHEAD (CANTILEVER) MOUNTING	4-16
FIGURE 4.9: MOUNTING OF A PEDESTRIAN OR PEDAL CYCLE LIGHT SIGNAL	4-17
FIGURE 4.10: EXAMPLE OF TRAFFIC SIGNAL LAYOUT PLAN	4-18
FIGURE 5.1: JUNCTION INFORMATION SIGN SEQUENCE: CLASS C OR D ROAD	5-4
FIGURE 5.2: GROUND MOUNTED EXIT DIRECTION SIGNS: CLASS A OR B ROAD ACCESS INTERCHANGE	5-6
FIGURE 5.3: OFF-RAMP DIRECTION SIGNING.....	5-7
FIGURE 5.4: GROUND MOUNTED CROSS DIRECTION SIGN SEQUENCE – DIAMOND INTERCHANGE	5-8

FIGURE 5.5: OVERHEAD EXIT DIRECTION SIGN SEQUENCE – ACCESS INTERCHANGE.....	5-9
FIGURE 5.6: OVERHEAD DIRECTION SIGN SEQUENCE: SYSTEMS INTERCHANGE	5-10
FIGURE 5.7: GROUND MOUNTED CROSS ROAD DIRECTION SIGN SEQUENCE – PARCLO INTERCHANGE.....	5-11
FIGURE 5.8: PLACEMENT OF REGULATORY AND WARNING SIGNS (SHOULDER).....	5-12
FIGURE 5.9: PLACEMENT OF REGULATORY AND WARNING SIGNS (KERB AND SIDEWALK)	5-13
FIGURE 5.11: PLACEMENT OF MULTIPLE SUPPORT INFORMATION SIGNS	5-15
FIGURE 5.12: PLACEMENT OF MULTIPLE SUPPORT INFORMATION SIGNS	5-15
FIGURE 5.13: PLACEMENT OF OVERHEAD CANTILEVER SIGNS	5-17
FIGURE 5.14: PLACEMENT OF OVERHEAD GANTRY SIGNS	5-18
FIGURE 5.15: TYPICAL UK HIGHWAY NETWORK SIGNAGE.....	5-22
FIGURE 5.16: TYPICAL INFORMATION SIGN DESIGNS USING TRAFSOFT	5-28
FIGURE 5.17: MINOR CROSSROAD JUNCTION	5-29
FIGURE 5.18: MINOR T-JUNCTION	5-30
FIGURE 5.19: CROSS ROAD JUNCTION WITH LEFT TURN LANES	5-31
FIGURE 5.20: CROSSROAD JUNCTION WITH 4-LANE MAJOR ROAD	5-32
FIGURE 5.21: TRAFFIC CIRCLE.....	5-33
FIGURE 5.22: SIGNALIZED MULTI LANE ROAD	5-34

LIST OF TABLES

TABLE 1.1: PROPOSED NIGERIA ROAD CLASS.....	1-8
TABLE 3.1: MODULE DIMENSION FOR DIVIDING LINE	3-5
TABLE 3.2: MODULE DIMENSION FOR LANE LINE	3-6
TABLE 3.3: BARRIER SIGHT DISTANCE FOR NO OVERTAKING LINE	3-13
TABLE 3.4: RECOMMENDED SYMBOL LENGTHS	3-23
TABLE 4.1: SIGHT DISTANCES FOR TRAFFIC SIGNALS.....	4-13
TABLE 5.1: SIGHT DISTANCES FOR WARNING SIGNS.....	5-2
TABLE 5.2: DISTANCE OF ADVANCE DIRECTION SIGNS FROM A ROAD JUNCTION	5-5
TABLE 5.3: PERMANENT SIGN PLACEMENT DIMENSIONS (REGULATORY AND WARNING SIGNS)	5-14
TABLE 5.4: PERMANENT SIGN PLACEMENT DIMENSIONS (GROUND MOUNTED INFORMATION SIGNS).....	5-16
TABLE 5.5: PERMANENT SIGN PLACEMENT DIMENSIONS (OVERHEAD	5-19
TABLE 5.7: SIZES OF WARNING SIGNS	5-20
TABLE 5.8: WIDTH OF SIGN BORDERS (MM).....	5-20
TABLE 5.9: RECOMMENDED (AVERAGE) LETTER SIZES – RURAL ROADS	5-24
TABLE 5.10: RECOMMENDED (AVERAGE) LETTER SIZES – URBAN ROADS	5-26
TABLE 5.11: SIGNS AND MARKINGS CHECK LIST	5-35
TABLE 6.1: EXAMPLE SUPPORTING STRUCTURE FOR SIGNS	6-5

1 General Principles

1.1 Description of the Highway Manual

1.1.1 Introduction to the Manual

The Highway Manual aims to guide members of staff of the Ministry and engineering practitioners, with regard to standards and procedures that the Government deems acceptable for the planning, design, construction, maintenance, operation and management of roads. The Manual directs practitioners to other reference documents of established practice where the scope of the Manual is exceeded; provides a nationally recognized standard reference document; and provides a ready source of good practice for the development and operation of roads in a cost effective and environmentally sustainable manner.

1.1.2 Arrangement of the Manual

The Highway Manual comprises a Code of Procedure and two Parts, each of which has been divided up into separate volumes, in the manner shown in Figure 1.1 **Error! Reference source not found.**

1.2 Overview of Volume VI

The provision of traffic signs and road markings is essential for the efficient and safe operation of the road network. Roads with poor signage or badly maintained signs are unsatisfactory roads and cannot operate to their full traffic carrying potential and capacity. Standardised traffic signage and road markings are a prerequisite for effective traffic control and law enforcement.

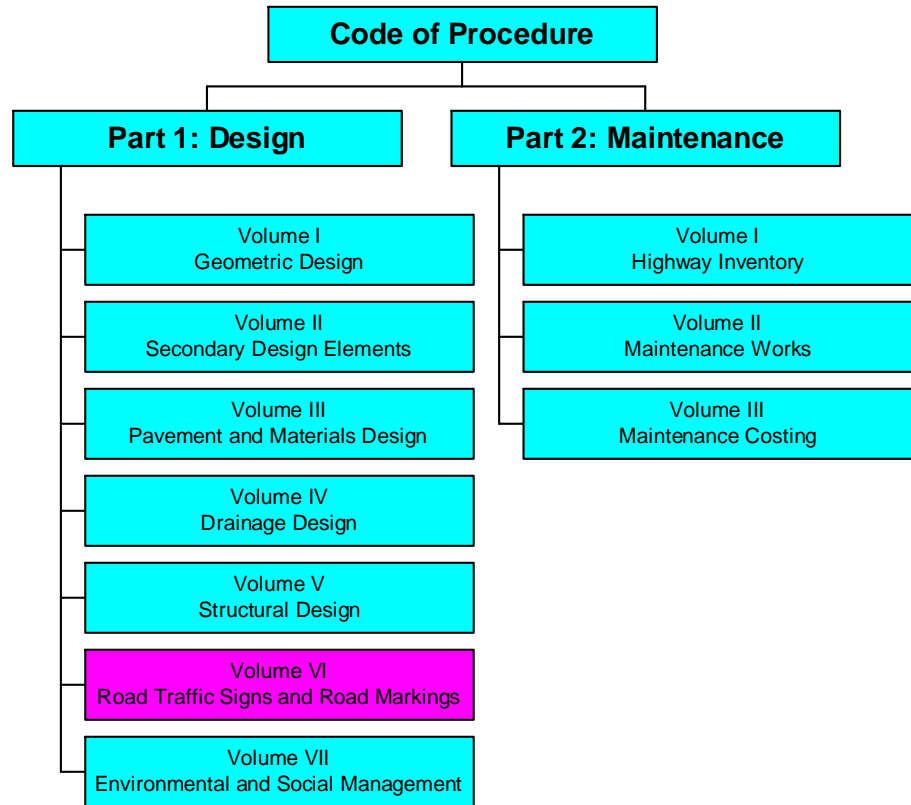

Figure 1.1: Arrangement of Highway Manual

Traffic signs, including road markings, road studs, bollards, traffic signals and other devices must convey a clear message to the road user. The message must be easily understood and must be conveyed at the correct time and position on the road for the driver to be able to react appropriately.

The road signs in use in Nigeria are contained in the Highway Code as discussed below. This manual is intended to supplement this information with technical detail for use by practitioners engaged in the design of roads, to provide a standardised traffic sign system as an integral part of the design process.

The manual provides a description of regulatory, warning and direction signs, road markings and traffic signals, and provides guidelines for the applications and positioning of signs. Although technical detail is provided as a general guide, the manual is not

intended to replace authoritative reference works that are generally available, but provides guidance as to where additional information can be obtained if required. Furthermore, modern design methods make extensive use of computer software to carry out designs, and there are several packages available that can provide readymade technical solutions to most signage design problems. References are thus provided to appropriate software sources.

1.3 Road Signs and Markings

The Federal Republic of Nigeria is a signatory to the Vienna Convention on Road Signs and Signals, agreed upon by the United Nations Economic and Social Council at its Conference on Road Traffic in Vienna, from 7 October 1968 to 8 November 1968, which came into force on 6 June 1978. The convention revised and substantially extended the earlier 1949 Geneva Protocol on Road Signs and Signals, itself based in turn on the 1931 Geneva Convention concerning the Unification of Road Signals.^(Wikipedia)

This is an international treaty designed to increase road safety and aid international road traffic by standardising the signing system for road traffic (road signs, traffic lights and road markings) in use internationally.

The traffic signs and road markings in use in Nigeria, based on the Convention, are contained in Schedule 9 of the National Road Traffic Regulations promulgated in the Federal Republic of Nigeria, Official Gazette No. 79, dated 21 September 2004, Government Notice No. 335, National Road Traffic Regulations 2004. Regulation 26(2) (h), Schedule 9 deals with the following:

- Road Markings: Edge and Lane Lines
- Traffic Light Signals
 - Regulatory Road Signs
 - Prohibitory and Mandatory Road Signs
 - Traffic Road Signs

- Warning Road Signs and
 - Informative Road Signs

Signs, signals and road markings are published for the road user in the Nigeria Highway Code published by the Federal Republic of Nigeria, Federal Road Safety Commission ^(Commission, 2008). It is compulsory in Nigeria for every road user to acquire this document as a companion and for training purposes.

Nigeria's total road network is estimated to be 194 000 kilometres of Federal, State and local roads, and in 2011 Nigeria had the second largest road network in Africa. Between 1978 and 1987 the motor vehicle fleet is reported to have increased by 183 percent as a result of increased motor vehicle ownership. Approximately 90 percent of passengers and freight rely on the road network for transportation ^(Corps, 2012). According to the Nigeria Road Safety Strategy 2012, the average fatality rate on Nigeria's roads over the last five years is five per 100 000 population i.e. an average of 5 000 deaths and 21 000 injuries per annum.

One of the strategic goals contained in the Nigeria Road Safety Strategy 2012 is to improve road infrastructure for all users by, inter alia, defining design standards for all roads and performing safety assessments on roads. This includes the strategic activities of developing and implementing national standards on traffic signs and road markings based on the recommendations of the Geneva Convention, and preventing the defacement of road signs and illegal construction of speed bumps on highways.

This manual provides a national standard for traffic signs and road markings and sets out a practical methodology for the application of the Nigeria traffic signs and road markings on Nigeria's highway and road network, with the objectives of achieving standardization between implementing authorities, the improvement of traffic signage and road markings in Nigeria, and contributing to the reduction of road accidents.

1.4 International Road Signs and Markings

The Vienna Convention on Road Signs and Signals ^(United-Nations, 2006) provides the standard symbols for signs and instructions for their use. The standards describe the colours of regulatory and prohibitory traffic signs as having a red border with the ground being either white or yellow. In Nigeria the colour convention adopted is the yellow ground.

Although based on the same convention, the signs used in Nigeria are different to those used in the United Kingdom, and other European countries, for example, where a white background is used for warning and regulatory signs as opposed to the yellow background used in Nigeria. One of the main considerations when considering the standardization of traffic signs is the need to harmonize with the convention adopted in neighbouring states, particularly those with whom a country has strong economic ties.

The Southern African Development Community (SADC) has adopted the signs convention contained in the SADC Road Traffic Signs Manual ^(Department of Transport, South Africa, May 2012), which are similar to the United Kingdom standard. Angola, Botswana, Congo, Lesotho, Malawi, Mauritius, Mozambique, Namibia, Seychelles, South Africa, Tanzania, Zambia and Zimbabwe comprise the SADC.

1.5 Requirements and Principles for Traffic Signs and Road Markings

The function of traffic signs and road markings is to regulate traffic, warn road users of hazards and regulations ahead and to guide traffic by indicating direction and distance. In order to fulfil these functions, signs and markings should be needed in a particular situation, be clear and be adhered to by the motorist. Signs and markings should therefore be properly designed and be appropriate for a particular situation. They should also be well maintained.

Signs and markings must comply with national standards throughout the area or country where they are implemented so that road users are assured of the same standards wherever they are. They must also be clear and convey an easily understood message. They must also be uniform in layout and colour.

It is also important that not too many signs be used and that they are only installed where they are really effective. However, some signs need to be installed at regular intervals in order to provide continuity e.g. navigational information.

The application of signs and markings should also be uniform and similar situations must be treated in the same way. Uniformity is also important for law enforcement and traffic safety.

Traffic signs and road markings must only be erected by an appropriate authority having official jurisdiction. No advertising should be affixed to a traffic sign or its supports.

The following general principles should be adhered to:

- Symbols or diagrams should be used in preference to words
- Signs should have the same appearance by day as by night e.g. by the use of retro-reflective material
- The amount of information on a sign should be limited to that which can easily be absorbed by a motorist.

In order for the information (guidance) signing system to be effective, a navigation system needs to be developed for Nigeria. A navigation system would comprise the following:

- The classification and numbering of the main road network
- The preparation of a map indicating the major routes and route numbers
- The identification and classification of nodes and destinations to be used on information signs.

The above would enable local motorists and visitors to plan their routes and to find their destinations using information signs system based on the route numbering and destination classification.

The preparation of a navigation system is not within the scope of this document.

1.6 Classification of Roads, Traffic Signs and Road Markings

The Nigerian road network can be divided into the following classes according to their major function in the road network (refer to Volume 1: Geometric Design, Chapter 2 for a full description) as indicated in Table 1.1:

The road classification is important because the different classifications have different requirements in respect of traffic signs and road markings. The positioning of signs depends on sight distance which is governed by the design speed of the road e.g. expressways may have a design speed of 100 to 120km/hr whereas minor roads have a speed limit of 60km/hr.

Higher order roads should have larger signs commensurate with the higher design speed (See Table 5.6 and Table 5.7) and information signs (direction and advance direction signs) will be more complex due to the presence of interchanges.

The following sections will provide guidelines for the positioning and sizing of signs according to road classification and hence design speed.

Table 1.1: Proposed Nigeria Road Class

Road Class	
Category	Known routes
Class A: International and National Trunk Roads	Roads that link provincial capitals, main centres of population and nationally important centres. Major function is to provide mobility.
Class B: Primary Roads	Roads linking provincially important centres to each other or to a higher class road (urban/rural centres). Linkage between districts local centres of population and development areas with higher class road. Major function is to provide both mobility and access.
Class C: Secondary Roads	Roads linking locally important centres to each other, to a more important centre, or to a higher class road (rural/market centres) and linkage between locally important traffic generators and their rural hinterland. Function is to provide both mobility and access.
Class D: Minor Roads	Any road linking to minor centres (market/local centre) and all other trafficable roads. Major function is to provide access to land adjacent to the secondary road system.

Traffic signs are used to control and guide traffic and to promote road safety, and should therefore be used where they can effectively fulfil these functions. The signs to be used must be appropriate to the situation otherwise they will not be heeded by road users. Signs should also be provided if they are needed to improve the situation, otherwise the objectives of serving the public will not be fulfilled.

In Nigeria there are three basic classifications of road signs, based on the Vienna Convention on Road Signs and Signals, as mentioned in the above sections. These are:

a. Regulatory Signs

These include all signs which give notice of requirements, prohibitions or restrictions. They may be either mandatory or prohibitory. Regulatory signs are basically circular in shape and may be supplemented by plates beneath them augmenting the message given by the sign. The exception to this is the STOP sign which is hexagonal.

b. Warning Signs

These signs give warning of a hazard ahead. The design of most warning signs is based on an equilateral triangle having its apex uppermost. The exception to this is the YIELD (GIVE WAY) sign which is an inverted triangle (apex lowermost). They are sometimes supplemented by rectangular plates giving additional information as may be necessary.

c. Information Signs

These signs normally give road users information about the route and about places and facilities of particular value or interest. Most information signs are rectangular but some direction signs (FINGERBOARDS) have one end pointed to indicate direction.

d. Road Markings

Road markings are paint, other materials applied to the road surface, road studs or delineators for the purpose of guiding, warning or regulating traffic. Road markings can be used on their own or in combination with traffic signs.

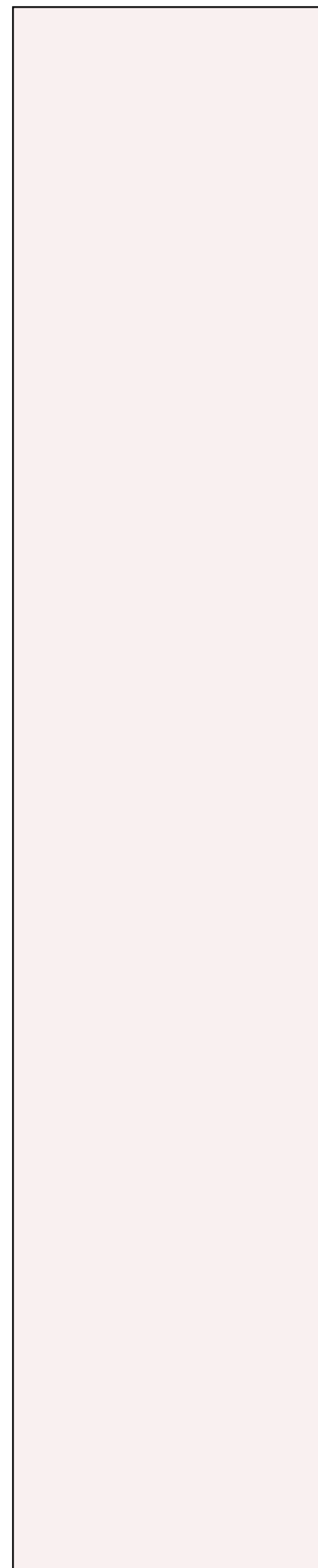

e. Traffic Signals

Traffic signals comprise standardised electronic devices of a series of light indications to regulate the flow of traffic, cyclists and pedestrians.

The following diagram indicates the classification of traffic signs, road markings and traffic signals in Nigeria.

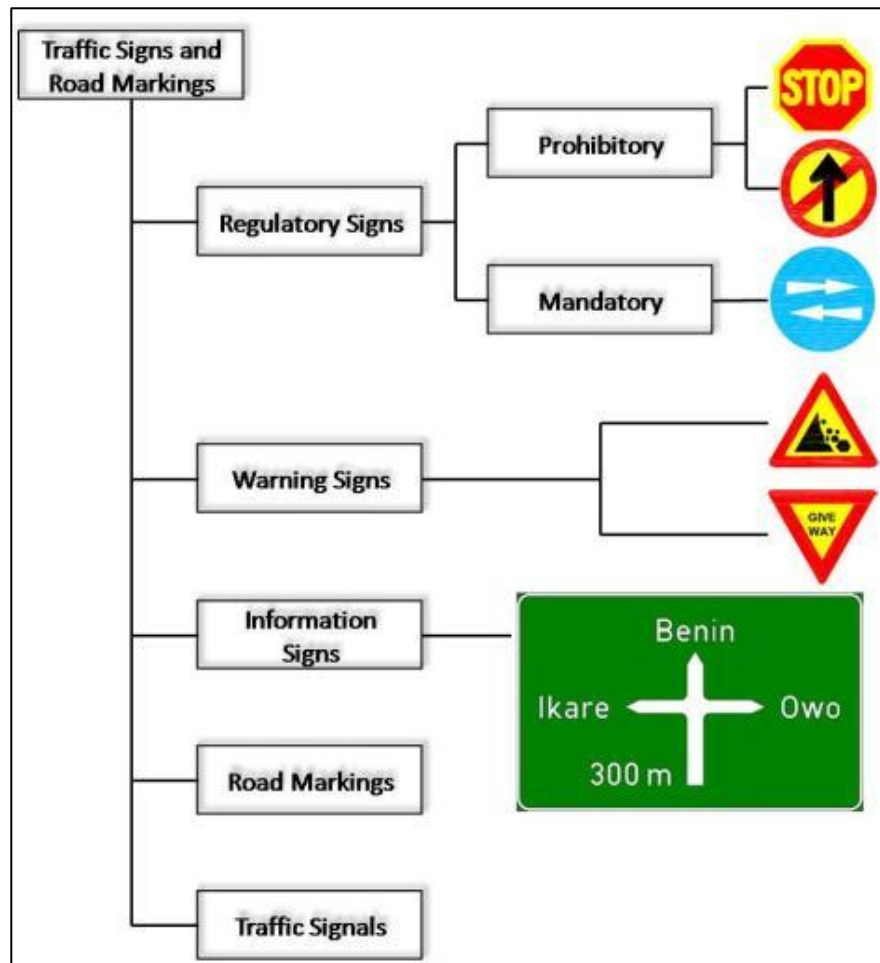

Figure 1.2: Signs Classification

2 Traffic Signs

2.1 Regulatory Signs (Prohibitory)

The Regulatory (Prohibitory) signs currently adopted for use in Nigeria are presented below in terms of the sign number (cross referenced to the Convention on Traffic Signs ^(United-Nations, 2006)), function, requirements, colour and diagrammatic representation.

STOP SIGN

B, 2a

Colours:

Border: Yellow retro-reflective

Background: Red retro-reflective

Legend: Yellow retro-reflective

Height not less than one third the height of the panel.

The STOP shall be used to notify drivers that, at the intersection where the sign is placed, they shall stop before entering the intersection and give way to vehicles on the road that they are approaching. Three-way and four-way stops can be used at a junction provided the stop signs have a special supplementary plate in the same colours as the stop sign indicating the figures “3” or “4”. All-way stop control can be used in place of a traffic signal as a temporary measure, but is not recommended for use on dual carriageway roads.

Stop signs should be positioned as close to the painted stop line as possible (if one is provided) and should be positioned on the right hand side of the road. The sign can be repeated on the left hand side if the road is a dual carriageway or a one way road with more than one lane, or if there is channelization at the intersection.



**NO ENTRY****C, 1b****Colours:**

Border: Red retro-reflective

Background: Yellow retro-reflective

Legend: Black semi-matt

Notification that entry is prohibited for all vehicles in the direction indicated. This sign is used to indicate the incorrect direction on a one-way road, freeway off ramps and car park exits.

The sign should be positioned at the point where no entry is permitted and must be placed on the right hand side of the road. For additional emphasis the sign can be repeated on the left hand side.

CLOSED TO ALL VEHICLES IN BOTH DIRECTIONS**C, 2****Colours:**

Border: Red retro-reflective

Background: Yellow retro-reflective

Legend: None

Notification that all vehicular traffic in both directions is prohibited.

This sign is normally used for shopping streets, pedestrian zones and “play streets”. A supplementary plate should be used to advise of the specific time of day or day of the week when the sign is applicable or if access to local properties is permitted. The sign should be positioned at the point from where the restriction applies.

(The image on the left has disappeared for some reason)

NO ENTRY FOR MOTORCYCLES**C, 3b****Colours:**

Border:	Red retro-reflective
Background:	Yellow retro-reflective
Legend:	Black semi-matt

Notification that entry is prohibited for a certain category of vehicle or road use (motorcycles).

The sign should be displayed at the beginning of a road, path or sidewalk where motorcycles are not permitted e.g. for safety reasons. An advance sign with a supplementary plate indicating the distance to the point of the prohibition may be required.

**NO ENTRY FOR CYCLES****C, 3c****Colours:**

Border:	Red retro-reflective
Background:	Yellow retro-reflective
Legend:	Black semi-matt

Notification that entry is prohibited for a certain category of vehicle or road use (cycles or pedal-cycles).

The sign should be displayed at the beginning of a road, path or sidewalk where cyclists are not permitted e.g. for safety reasons.





NO ENTRY FOR VEHICLES HAVING AN OVERALL WIDTH EXCEEDING METRES

C, 5

Colours:

Border: Red retro-reflective

Background: Yellow retro-reflective

Legend: Black semi-matt

Notification that entry is prohibited for a certain category of vehicle or road use (overall vehicle width).

The sign should be positioned on or immediately in advance of the structure to which the height restriction applies. The sign should be positioned on the right hand side of the road.



NO ENTRY FOR VEHICLES HAVING AN OVERALL HEIGHT EXCEEDING METRES

C, 6

Colours:

Border: Red retro-reflective

Background: Yellow retro-reflective

Legend: Black semi-matt

Notification that entry is prohibited for a certain category of vehicle or road use (vehicle width).

The sign should be positioned on or immediately in advance of the structure to which the height restriction applies. The sign should be positioned on the right hand side of the road.

**NO ENTRY FOR VEHICLES EXCEEDING METRIC TONNE
LADEN LOAD****C, 7****Colours:**

Border:	Red retro-reflective
Background:	Yellow retro-reflective
Legend:	Black semi-matt

Notification that entry is prohibited for a certain category of vehicle or road use (laden mass). Vehicles must not proceed beyond the sign.

The sign should be positioned at a point from where the restriction applies or where vehicles still have the opportunity to turn around or deviate to another route. The sign should be positioned on the right hand side of the road and on dual carriageway roads the sign should be repeated on the left (median) side. On one way roads with more than one lane, the sign should be repeated on the left hand side of the road.

**NO ENTRY FOR VEHICLES HAVING AN AXLE LOAD
EXCEEDING.....METRIC TONNES****C, 8****Colours:**

Border:	Red retro-reflective
Background:	Yellow retro-reflective
Legend:	Black semi-matt

Notification that entry is prohibited for a certain category of vehicle or road use (tonnes on one axle).

The sign should be positioned at a point from where the restriction applies or where vehicles have the opportunity to turn around or deviate to another route. The sign should be positioned on the right hand side of the road. (P.S Image on the right)



**NO LEFT TURN****C, 11a****Colours:**

Border: Red retro-reflective

Background: Yellow retro-reflective

Legend: Black semi-matt

Notification that turning is prohibited to the left.

The sign should normally be placed at or in advance of a junction where left turns are not permitted e.g. to improve safety by restricting turning movements at a junction or when the cross road is a one way road. The signs should not be used to replace one way sign on the cross road. The signs should be placed on the left hand side of the road and 15 to 30 metres in advance of the junction.

**NO RIGHT TURN****C, 11b****Colours:**

Border: Red retro-reflective

Background: Yellow retro-reflective

Legend: Black semi-matt

Notification that turning is prohibited to the right.

The sign should normally be placed at or in advance of a junction where right turns are not permitted e.g. to improve safety by restricting turning movements at a junction or when the cross road is a one way road. The signs should not be used to replace one way sign on the cross road. The signs should be placed on the right hand side of the road and 15 to 30 metres in advance of the junction.

NO U-TURN**C, 12****Colours:**

Border:	Red retro-reflective
Background:	Yellow retro-reflective
Legend:	Black semi-matt

Notification that U-turns are prohibited is usually applicable at junctions (including signalised junctions), gaps in the median island of a section or roadway, for safety or traffic control purposes.

The sign should be placed within 15 metres ahead of the junction or median opening. The sign should be placed on the median island if one exists or in a position where it can easily be seen.

**OVERTAKING PROHIBITED****C, 13****Colours:**

Border:	Red retro-reflective
Background:	Yellow retro-reflective
Legend:	Black semi-matt

Notification that overtaking, other than by motorcycles or mopeds, without a sidecar, is prohibited.

Overtaking is normally regulated by a barrier line road marking if there is a permanent road surface. A no-overtaking sign can be used to reinforce the restriction or if the road is wide enough so that two vehicles can overtake without crossing the barrier line. The sign can also be used on roads where there is a gravel surface. If the length of road over which the restriction applies, the sign should be repeated every 500 metres. The sign is normally displayed on the right hand side of the road at the position from which the restriction applies.





SPEED LIMIT (MAXIMUM)

C, 14

Colours:

Border: Red retro-reflective

Background: Yellow retro-reflective

Legend: Black semi-matt

Notification of a speed limit indicates the maximum speed in the unity normally used.

The sign should be positioned on the right hand side of the road at the point from where the restriction applies, and on dual carriageway roads the sign should be repeated on the left (median) side. On one way roads with more than one lane, the sign should be repeated on the left hand side of the road. A speed limit sign normally cancels the preceding speed limit sign and where the speed is reduced, it should be indicated by a series of signs 150 to 200 metres apart indicating the speed limit in 20 km/hr increments e.g. 120 – 100 – 80 km/hr.



USE OF AUDIBLE WARNING DEVICES PROHIBITED

C, 15

Colours:

Border: Red retro-reflective

Background: Yellow retro-reflective

Legend: Black semi-matt

Notification that the use of audible warning devices is prohibited except to avoid an accident.

The sign should be placed 50 metres in advance of the beginning of the area to which the restriction applies and should have a supplementary plate indicating the distance over which the restriction applies.

PASSING WITHOUT STOPPING PROHIBITED (LEGEND CAN VARY EG: CUSTOMS, POLICE CHECK, HIGHWAY SURVEY)

C, 16

Colours:

Border:	Red retro-reflective
Background:	Yellow retro-reflective
Legend:	Black semi-matt

Notification of the proximity of a Customs House at which a stop is compulsory. The sign should include the word "CUSTOMS" preferably in two languages. The sign can also be used to notify drivers that passing without stopping is prohibited for other reasons. In that case the word "CUSTOMS" can be replaced by another word indicating the reason for the stop e.g. "POLICE CHECK" or "HIGHWAY SURVEY".

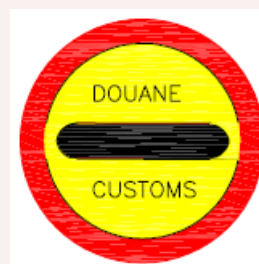

DERESTRICTION (END OF ALL LOCAL PROHIBITIONS IMPOSED ON MOVING VEHICLES)

C, 17a

Colours:

Border:	None
Background:	Yellow retro-reflective
Legend:	Black semi-matt

The point at which all prohibitions notified by prohibitory signs for moving vehicles cease to apply.

The signs should be displayed on the right hand side of single carriageway roads and on the right and left hand side of dual carriageway roads.





PARKING PROHIBITED

C, 18

Colours:

Border: Red retro-reflective

Background: Yellow retro-reflective

Legend: Black semi-matt

Indication of places where no parking is permitted. The scope of the prohibition may be restricted by the provision of an additional plate below the sign indicating the days of the week, month or times of the day during which the prohibition applies.

The sign is normally placed perpendicular to the edge of the road or at a slight angle to it, and only applies to the side of the road on which it is erected. An additional panel may be displayed below the sign indicating the distance over which the restriction applies, or the distance may be indicated on the sign itself.

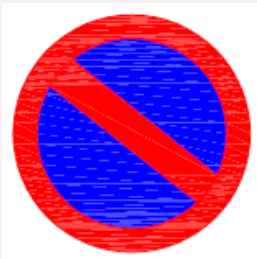

NO WAITING (STANDING PROHIBITED)

C, 18

Colours:

Border: Red retro-reflective

Background: Blue retro-reflective

Legend: None

Indication of places where no waiting is permitted. The scope of the prohibition may be restricted by the provision of an additional plate below the sign indicating the days of the week, month or times of the day during which the prohibition applies.

The sign is normally placed perpendicular to the edge of the road or at a slight angle to it, and only applies to the side of the road on which it is erected. An additional panel may be displayed below the sign indicating the distance over which the restriction applies, or the distance may be indicated on the sign itself.

NO STOPPING (STANDING AND PARKING PROHIBITED)**C, 19****Colours:**

Border: Red retro-reflective

Background: Blue retro-reflective

Legend: None

Indication of places where no stopping (standing and parking) is permitted. The scope of the prohibition may be restricted by the provision of an additional plate below the sign indicating the days of the week, month or times of the day during which the prohibition applies.

The sign is normally placed perpendicular to the edge of the road or at a slight angle to it, and only applies to the side of the road on which it is erected. An additional panel may be displayed below the sign indicating the distance over which the restriction applies, or the distance may be indicated on the sign itself.

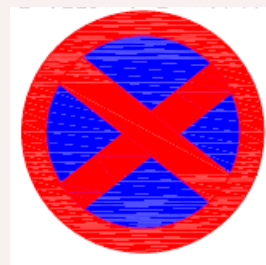
**GIVE WAY TO TRAFFIC ON YOUR LEFT****C, 21****Colours:**

Border: Red retro-reflective

Background: Yellow retro-reflective

Legend: Black semi-matt

Notification to give way (yield) to traffic passing on the left lane of a dual carriageway road.

To encourage drivers to drive in the right hand lane and to pass in the left hand (median) lane. The sign is normally placed where deemed appropriate to encourage good driving habits.





LITTER PROHIBITED

C, 22

Colours:

Border:	Red retro-reflective
Background:	Yellow retro-reflective
Legend:	Black semi-matt

Notification to drivers that littering is prohibited.

The sign is normally placed where deemed appropriate to encourage good driving habits.

2.2 Regulatory Signs (Mandatory)

The Regulatory (Mandatory) signs currently adopted for use in Nigeria are presented below in terms of the sign number (cross referenced to the Convention on Traffic Signs ^(United-Nations, 2006)), function, requirements, colour and diagrammatic representation.



DIRECTION TO BE FOLLOWED (PROCEED STRAIGHT ONLY)

D, 1a

Colours:

Border:	None
Background:	Blue retro-reflective
Legend:	White semi-matt

The direction in which vehicles are obliged to proceed, or the only direction in which they are permitted to proceed is indicated by means of an arrow or arrows pointing in the appropriate direction or directions.

The sign should be placed on the right in advance of a junction.

DIRECTION TO BE FOLLOWED (PROCEED RIGHT ONLY)**D, 1a****Colours:**

Border: None

Background: Blue retro-reflective

Legend: White semi-matt

The direction in which vehicles are obliged to proceed, or the only direction in which they are permitted to proceed is indicated by means of an arrow or arrows pointing in the appropriate direction or directions.

The sign should be placed on the far side of a one way roadway facing traffic entering from the side road at a T-junction, so that traffic turns in front of the sign.

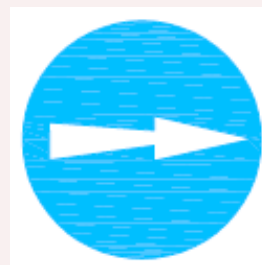
**DIRECTION TO BE FOLLOWED (PROCEED LEFT ONLY)****D, 1a****Colours:**

Border: None

Background: Blue retro-reflective

Legend: White semi-matt

The direction in which vehicles are obliged to proceed, or the only direction in which they are permitted to proceed is indicated by means of an arrow or arrows pointing in the appropriate direction or directions.

The sign should be placed on the far side of a one way roadway facing traffic entering from the side road at a T-junction, so that traffic turns in front of the sign.

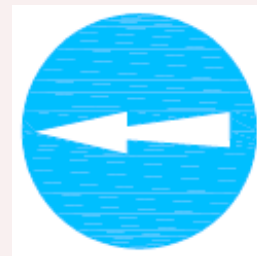

**DIRECTION TO BE FOLLOWED (PROCEED RIGHT OR LEFT)****D, 1a****Colours:**

Border:	None
Background:	Blue retro-reflective
Legend:	White semi-matt

The direction in which vehicles are obliged to proceed, or the only direction in which they are permitted to proceed is indicated by means of an arrow or arrows pointing in the appropriate direction or directions.

The sign should be placed on the right in advance of a junction.

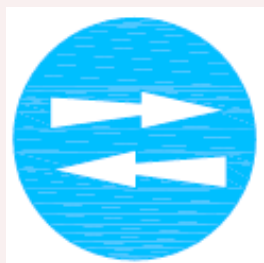
**DIRECTION TO BE FOLLOWED (TWO WAY TRAFFIC CROSS ROAD)****D, 1a****Colours:**

Border:	None
Background:	Blue retro-reflective
Legend:	White semi-matt

The direction in which vehicles are obliged to proceed, or the only direction in which they are permitted to proceed is indicated by means of an arrow or arrows pointing in the appropriate direction or directions.

The sign is normally used to warn road users on a one way road that the next cross street carries two way traffic. The sign should be placed on both sides of the road 60 metres in advance of the cross road.

DIRECTION TO BE FOLLOWED (TWO WAY TRAFFIC, TWO LANES)**D, 1a****Colours:**

Border: None

Background: Blue retro-reflective

Legend: White semi-matt

The direction in which vehicles are obliged to proceed, or the only direction in which they are permitted to proceed is indicated by means of an arrow or arrows pointing in the appropriate direction or directions.

The sign is normally used to warn road users on a one way section of road that the road becomes a two lane two way road ahead, or where it may be unclear to road users, that the road they are currently on carries two way traffic. The sign should be placed on both sides of a one way road in advance of the point where the two way road begins.

**DIRECTION TO BE FOLLOWED (TWO WAY TRAFFIC, FOUR LANES)****D, 1a****Colours:**

Border: None

Background: Blue retro-reflective

Legend: White semi-matt

The direction in which vehicles are obliged to proceed, or the only direction in which they are permitted to proceed is indicated by means of an arrow or arrows pointing in the appropriate direction or directions.

The sign is normally used to warn road users on a one way section of road that the road becomes a four lane two way road ahead, or where it may be unclear to road users, that the road they are currently on carries two way traffic. The sign should be placed on both sides of a one way road in advance of the point where the two way road begins.





DIRECTION TO BE FOLLOWED (BEGINNING OF DIVIDED TWO LANE TWO WAY ROAD)

D, 1a

Colours:

Border: None

Background: Blue retro-reflective

Legend: White semi-matt / Black semi-matt

The direction in which vehicles are obliged to proceed, or the only direction in which they are permitted to proceed is indicated by means of an arrow or arrows pointing in the appropriate direction or directions.

The sign is normally used to warn road users on a two way section of road that the road becomes a divided two lane two way road with a central median island. The sign should be placed on the right in advance of the point where the two way divided road begins.

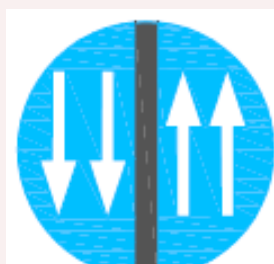

DIRECTION TO BE FOLLOWED (BEGINNING OF DIVIDED FOUR LANE TWO WAY ROAD)

D, 1a

Colours:

Border: None

Background: Blue retro-reflective

Legend: White semi-matt / Black semi-matt

The direction in which vehicles are obliged to proceed, or the only direction in which they are permitted to proceed is indicated by means of an arrow or arrows pointing in the appropriate direction or directions.

The sign is normally used to warn road users on a two way section of road that the road becomes a divided four lane two way road with a central median island. The sign is normally used in combination with a CARRIAGE WIDENS A, 4a sign. The sign should be placed on the right in advance of the point where the four lane two way divided road begins.

DIRECTION TO BE FOLLOWED (END OF DIVIDED FOUR LANE TWO WAY ROAD)**D, 1a****Colours:**

Border: None

Background: Blue retro-reflective

Legend: White semi-matt / Black semi-matt

The direction in which vehicles are obliged to proceed, or the only direction in which they are permitted to proceed is indicated by means of an arrow or arrows pointing in the appropriate direction or directions.

The sign is normally used to warn road users on a four lane two way section of road that the road becomes a two lane two way road. The sign is normally used in combination with a CARRIAGE NARROWS A, 4a sign. The sign should be placed on the right in advance of the point where the four lane two way divided road ends.

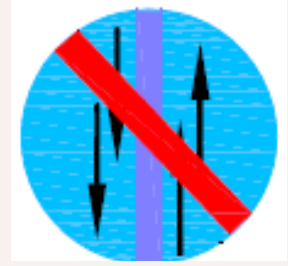



PASS THIS SIDE

D, 2

Colours:

Border: None

Background: Blue retro-reflective

Legend: White semi-matt

The sign is normally placed on a median island or obstacle in the roadway and means that vehicles must pass on the side of the median island or obstacle indicated by the arrow.

The sign normally indicates by means of a single arrow the side (right or left) by which a vehicle must pass. The arrow must be positioned at an angle of 45 degrees downwards and at a height of 750 millimetres above the road surface to avoid confusion with the PROCEED RIGHT OR PROCEED LEFT D, 1a sign.



COMPULSORY ROUNDABOUT

D, 3

Colours:

Border: None

Background: Blue retro-reflective

Legend: White semi-matt

The sign notifies drivers that they must follow the direction at a roundabout indicated by the arrows. If the sign D, 3 is displayed together with the sign GIVE WAY B, 1 or STOP B, 2, the driver in the roundabout has priority.

The sign is normally placed on the right hand side of the road at a point closest to the where the driver would have to stop if yielding to a vehicle in the roundabout.

COMPULSORY CYCLE TRACK**D, 4****Colours:**

Border: None

Background: Blue retro-reflective

Legend: White semi-matt

The sign notifies cyclists of a compulsory cycle track that is reserved for them and that other vehicles are not permitted to use the track. Cyclists are required to use the track if it is running parallel to a road or pedestrian footpath.

The sign is normally placed at the beginning of the compulsory cycle track.

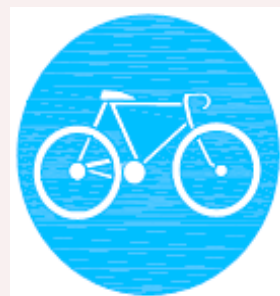
**COMPULSORY FOOTPATH****D, 5****Colours:**

Border: None

Background: Blue retro-reflective

Legend: White semi-matt

The sign notifies pedestrians of a compulsory footpath that is reserved for them and that other users are not permitted to use the footpath. Pedestrians are required to use the footpath if it is running parallel to a road or cycle track.

The sign is normally placed at the beginning of the compulsory footpath.

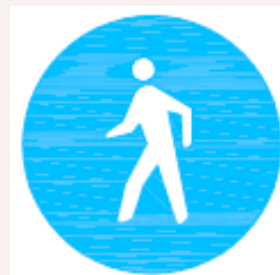



COMPULSORY MINIMUM SPEED LIMIT

D, 6

Colours:

Border: None

Background: Blue retro-reflective

Legend: White semi-matt

The sign means that vehicles using the road shall not travel less than the speed specified on the sign.

The sign is normally used where slow moving traffic will impede the safe flow of normal traffic on a freeway. The maximum speed is 80km/hr. The sign should be repeated at 5km/hr intervals if the sign is not displayed at all entry points to the freeway. The sign can be displayed below a SPEED LIMIT C, 14 sign.



STOP (TEMPORARY)

D, 7

Colours:

Border: None

Background: Blue retro-reflective

Legend: White semi-matt

The sign is recommended for use at road works to control traffic where traffic is limited to one lane at a time, drivers' visibility is restricted or there is construction traffic crossing.

GO (TEMPORARY)**D, 8****Colours:**

Border: None

Background: Blue retro-reflective

Legend: White semi-matt

The sign is recommended for use at road works to control traffic where traffic is limited to one lane at a time, drivers' visibility is restricted or there is construction traffic crossing.

**END DIVERSION (TEMPORARY)****D, 9****Colours:**

Border: None

Background: Blue retro-reflective

Legend: White semi-matt

The sign is recommended for use at road works to indicate to traffic the end of a temporary diversion of the road due to road works for example.



EXPRESSWAY

NO STOPPING

NO L-drivers

Motorcycle under 50cc

Mopeds, Pedal-cycles

Invalid carriages, Prams

Pedestrians, Animals

Hand Pushed Trucks



EXPRESSWAY

D, 10

Colours:

Border: None

Background: Blue retro-reflective

Legend: White semi-matt

The sign is recommended for use at the beginning of an expressway to indicate the special restrictions that apply to traffic in terms of the classes of vehicle that are permitted to use an expressway.

PRIORITY FOR ONCOMING TRAFFIC

B, 5

Colours:

Border: None

Background: Blue retro-reflective

Legend: White semi-matt / Red semi - matt

The sign is normally used to give priority to traffic moving in one direction on a narrow section of road where passing is difficult or impossible, and where drivers can see the whole length of the narrow road clearly both at night and day.. The sign is erected facing the traffic that does not have priority.

The sign is normally used on a narrow bridge with only one lane at the traffic calming “pinch point” that is only wide enough for one car to proceed at a time. The sign is erected at the point where the narrow section begins and where a stationary car will not block an oncoming vehicle. The arrow on the sign indicating the direction having priority is white and the other direction is red.

2.3 Warning Signs

The Warning signs currently adopted for use in Nigeria are presented below in terms of the sign number (cross referenced to the Convention on Traffic Signs ^(United-Nations, 2006)), function, requirements, colour and diagrammatic representation.

DANGEROUS LEFT BEND

A, 1a

Colours:

Border: Red retro-reflective

Background: Yellow retro-reflective

Legend: Black semi-matt

Warning of a dangerous bend to the left.

The sign should be displayed in advance of an obscured curve that can only be negotiated safely by reducing speed. The sign should be located on the right hand side of the road in advance of the hazard.





DANGEROUS RIGHT BEND

A, 1b

Colours:

Border: Red retro-reflective

Background: Yellow retro-reflective

Legend: Black semi-matt

Warning of a dangerous bend to the right.

The sign should be displayed in advance of an obscured curve that can only be negotiated safely by reducing speed. The sign should be located on the right hand side of the road in advance of the hazard.



DANGEROUS DOUBLE BEND

A, 1c

Colours:

Border: Red retro-reflective

Background: Yellow retro-reflective

Legend: Black semi-matt

Warning of a succession of dangerous bends, the first to the left.

The sign should be displayed where bends of similar severity follow in close proximity. The sign should be located on the right hand side of the road in advance of the hazard.

DANGEROUS DOUBLE BEND**A, 1d****Colours:**

Border: Red retro-reflective

Background: Yellow retro-reflective

Legend: Black semi-matt

Warning of a succession of dangerous bends, the first to the right.

The sign should be displayed where bends of similar severity follow in close proximity. The sign should be located on the right hand side of the road in advance of the hazard.

**DANGEROUS DESCENT****A, 2c****Colours:**

Border: Red retro-reflective

Background: Yellow retro-reflective

Legend: Black semi-matt

Warning of a steep descent.

The sign should be displayed where the gradient is 10 percent or more. The sign should be located on the right hand side of the road in advance of the hazard.





STEEP ASCENT

A, 3c

Colours:

Border: Red retro-reflective

Background: Yellow retro-reflective

Legend: Black semi-matt

Warning of a steep ascent.

The sign should be displayed where the gradient is 15 percent or more or where the ascent is longer than 1600 metres and the gradient is 10 percent or more. The sign should be located on the right hand side of the road in advance of the hazard.



CARRIAGEWAY NARROWS

A, 4a or A, 4b

Colours:

Border: Red retro-reflective

Background: Yellow retro-reflective

Legend: Black semi-matt

Warning that the carriageway ahead narrows abruptly e.g. at a narrow bridge.

The sign should be located on the right hand side of the road in advance of the hazard.



CARRIAGEWAY WIDENS

A, 4a

Colours:

Border: Red retro-reflective

Background: Yellow retro-reflective

Legend: Black semi-matt

Warning that the carriageway ahead widens e.g. at the end of a dual carriageway road.

The sign should be located on the right hand side of the road in advance of the hazard.



UNEVEN ROAD

A, 7c

Colours:

Border: Red retro-reflective

Background: Yellow retro-reflective

Legend: Black semi-matt

Warning of sections of road that have bumps (speed bumps), dips or are in a bad condition and motorists should reduce speed.

The sign should be located on the right hand side of the road in advance of the hazard. In the case of speed bumps, the sign should be placed within 30 metres of the first speed bump in a series.





SLIPPERY ROAD

A, 9

Colours:

Border: Red retro-reflective

Background: Yellow retro-reflective

Legend: Black semi-matt

Warning of sections of road that may be particularly slippery and motorists should reduce speed.

The sign should be located on the right hand side of the road in advance of the hazard.



LOOSE GRAVEL

A, 10a

Colours:

Border: Red retro-reflective

Background: Yellow retro-reflective

Legend: Black semi-matt

Warning of sections of road on which gravel may be thrown up e.g. on a gravel road, after recent road construction or due to poor road maintenance.

The sign should be located on the right hand side of the road in advance of the hazard.

FALLING ROCK

A, 11a

Colours:

Border: Red retro-reflective

Background: Yellow retro-reflective

Legend: Black semi-matt

Warning of sections of road where there is a danger from falling rocks and as a result there may be rocks on the carriageway.

The symbol may be reversed depending on which side the hazard occurs. The sign should be located on the right hand side of the road in advance of the hazard.



PEDESTRIAN / PEDESTRIAN CROSSING

A, 12

Colours:

Border: Red retro-reflective

Background: Yellow retro-reflective

Legend: Black semi-matt

Warning of a marked pedestrian crossing (in which case the sign should indicate a marked crossing) or a section of road where there is a high concentration of pedestrian activity.

The sign should be located on the right hand side of the road in advance of the crossing or section of road.





CHILDREN CROSSING / BLIND PEOPLE CROSSING

A, 13

Colours:

Border: Red retro-reflective

Background: Yellow retro-reflective

Legend: Black semi-matt

Warning of a section of road where there is a high concentration of children e.g. at the entrance to a school or where there may be a special crossing for blind people.

The sign should be located on the right hand side of the road in advance of the section of road.

CATTLE OR OTHER ANIMALS CROSSING

A, 13

Colours:

Border: Red retro-reflective

Background: Yellow retro-reflective

Legend: Black semi-matt

Warning of a section of road where there is a particular danger of animals crossing. The symbol may be reversed.

The sign should be located on the right hand side of the road in advance of the section of road.

ROAD WORKS

A, 16

Colours:

Border: Red retro-reflective

Background: Yellow retro-reflective

Legend: Black semi-matt

Warning that temporary construction work is in progress on a section of road.

The sign should be located on the right hand side of the road in advance of the section of road. On dual carriageway roads the sign should be repeated on the left median side.



CROSSROAD

A, 18a

Colours:

Border: Red retro-reflective

Background: Yellow retro-reflective

Legend: Black semi-matt

Warning that a crossroad is ahead.

The sign may be used where there are no advance direction signs or where there is a history of accidents. The sign should be located on the right hand side of the road in advance of the section of road.



**T-JUNCTION (SIDE ROAD JUNCTION)****A, 18c****Colours:**

Border: Red retro-reflective

Background: Yellow retro-reflective

Legend: Black semi-matt



Warning that a junction with joining or leaving traffic to the right or left is ahead.

The sign should be used where there are no advance direction signs. The sign should be located on the right hand side of the road in advance of the section of road.

**Y-JUNCTION (SKEW JUNCTION)****A, 18d****Colours:**

Border: Red retro-reflective

Background: Yellow retro-reflective

Legend: Black semi-matt



Warning that a Y-junction is ahead where traffic is required to make a sharp acute turn to the left or right.

The sign should be used where there are no advance direction signs and can also be used where the junction is controlled by a STOP or YIELD sign. The sign should be located on the right hand side of the road in advance of the section of road.



T-JUNCTION (SKEW JUNCTION)**A, 18e****Colours:**

Border: Red retro-reflective

Background: Yellow retro-reflective

Legend: Black semi-matt

Warning that a T-junction is ahead where traffic is required to make a sharp acute turn to the left or right.

The sign should be used where there are no advance direction signs and can also be used where the junction is controlled by a STOP or YIELD sign. The sign should be located on the right hand side of the road in advance of the section of road.

**INTERSECTION WITH MAJOR / MINOR ROAD****A, 19a and A 19b****Colours:**

Border: Red retro-reflective

Background: Yellow retro-reflective

Legend: Black semi-matt

Warning of a junction, where road users have priority - INTERSECTION WITH A MAJOR ROAD A, 19a, or warning of a junction where road users must give way - INTERSECTION WITH A MINOR ROAD A, 19b.

The sign should be used where there are no advance direction signs and can also be used where the junction is controlled by a STOP or YIELD sign. The sign should be located on the right hand side of the road in advance of the section of road.



19 a



19 b



ROUNDABOUT

A, 22

Colours:

Border: Red retro-reflective

Background: Yellow retro-reflective

Legend: Black semi-matt

The sign notifies drivers of a roundabout ahead.

The sign is normally placed in advance of a roundabout and on the right hand side of the road.



LEVEL CROSSING WITH GATE

A, 25 and A, 29a; A, 29b; A, 29 c (Countdown Markers)

Colours:

Border: Red retro-reflective

Background: Yellow retro-reflective

Legend: Black semi-matt / Red retro-reflective



The sign provides warning of a level crossing with gates or staggered half-gates on either side of the railway line. The sign is accompanied by a series of three COUNTDOWN MARKERS bearing three, two and one bars. The first marker (3 bars) should be co-located with the LEVEL CROSSING WITH GATE A, 25 sign. The first marker should be located approximately 250 metres from the level crossing and the other two markers should divide the remaining length to the level crossing into equal lengths.

The sign should be located on the right hand side of the road. The bars on the markers should slope down towards the carriageway. An additional sign may be placed on the left hand side of the road for extra emphasis. In this case the slope of the bars should be reversed.

LEVEL CROSSING WITHOUT GATE

A, 26a and A, 29a; A, 29b; A, 29 c (Countdown Markers)

Colours:

Border: Red retro-reflective

Background: Yellow retro-reflective

Legend: Black semi-matt / Red retro-reflective

The sign provides warning of a level crossing without gates. The sign is accompanied by a series of three COUNTDOWN MARKERS bearing three, two and one bars. The first marker (3 bars) should be co-located with the LEVEL CROSSING WITH GATE A, 25 sign. The first marker should be located approximately 250 metres from the level crossing and the other two markers should divide the remaining length to the level crossing into equal lengths.

The sign should be located on the right hand side of the road. The bars on the markers should slope down towards the carriageway. An additional sign may be placed on the left hand side of the road for extra emphasis. In this case the slope of the bars should be reversed.

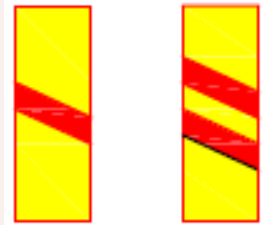



OTHER DANGERS

A, 32

Colours:

Border: Red retro-reflective

Background: Yellow retro-reflective

Legend: Black semi-matt

The sign notifies drivers that there is a danger of a general nature in the roadway ahead e.g. fallen tree, subsidence of the road, accident etc.

The sign is normally placed in advance of a danger or hazard in the road.



FERRY

A, 32

Colours:

Border: Red retro-reflective

Background: Yellow retro-reflective

Legend: Black semi-matt

The sign notifies drivers that there is a ferry at a river crossing ahead.

The sign is normally placed in advance on the right hand side of the road.

GIVE WAY (YIELD)**B, 1****Colours:**

Border: Red retro-reflective

Background: Yellow retro-reflective

Legend: Black semi-matt

The YIELD sign imposes a mandatory requirement that the driver must yield right of way to all traffic on the road that the driver is joining or traffic on a railway line that is being crossed.

The sign should be located on the right hand side of the road as close as possible to the yield line at a junction. On a one way road or on a dual carriageway road with a median, the sign may be repeated on the left hand side of the road.

GIVE WAY (YIELD) ADVANCE WARNING**B, 1 and H, 1 Additional Panel****Colours:**

Border: Red retro-reflective

Background: Yellow retro-reflective, Blue retro-reflective

Legend: White semi-matt

The sign provides advance warning of a junction controlled by a STOP or GIVE WAY sign where the sight distance to the junction is limited. A supplementary plate is provided indicating the distance to the junction.

The sign should be located in advance of the junction on the right hand side of the road.



275 metres

HAZARD MARKERS**Colours:**

Border:

Background: Yellow retro-reflective

Legend: Black or Red semi-matt

The sharp curve chevrons should be placed in multiples of three to mark horizontal curves that are considered to be a hazard. A T-junction chevron is used to warn that the road does not continue beyond the junction.



2.4 Information Signs

The Information signs currently adopted for use in Nigeria are presented below in terms of the sign number (cross referenced to the Convention on Traffic Signs ^(United-Nations, 2006)), function, requirements, colour and diagrammatic representation.

PLACE NAME

E, 7d

Colours:

Border: None

Background: Green retro-reflective

Legend: White retro-reflective

The sign indicates the name of a built up area.

The sign should be located on the right hand side of the road at the beginning of the built up area.

HOSPITAL

E, 13b

Colours:

Border: None

Background: Green retro-reflective

Legend: White retro-reflective, Red retro-reflective

The sign notifies drivers that they should take precautions near a medical facility (hospital) and they should not make unnecessary noise (hooting).

The sign should be located in advance of the hospital on the right hand side of the road. The sign may also be included on an advance direction sign.

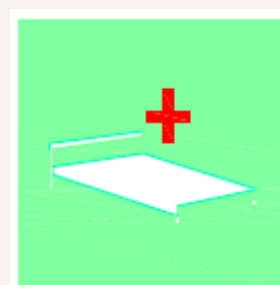

**PARKING****E, 14****Colours:**

Border: None

Background: Green retro-reflective

Legend: White retro-reflective

The sign indicates where parking is authorised. The sign may bear an inscription indicating the direction in which the parking is permitted or the time period for which parking is permitted. This information can also be indicated on a separate panel below the sign. The type of vehicle that is permitted to park must also be indicated by the appropriate inscription on the sign.

The sign should be located on the side of the road where the parking is permitted and should be erected at 90 degrees to the direction of travel.

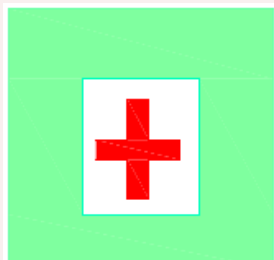
**FIRST AID STATION****F, 1a****Colours:**

Border: None

Background: Green retro-reflective

Legend: White retro-reflective, Red retro-reflective

The sign notifies drivers of the presence of a First Aid Station.

The sign should be located at the entrance to the facility. The sign may also be included on an advance direction sign.

MECHANICAL HELP (BREAKDOWN SERVICE)**F, 2****Colours:**

Border: None

Background: Green retro-reflective

Legend: White retro-reflective, Black semi-matt

The sign notifies drivers of the presence of mechanical help or a breakdown service.

The sign should be located at the entrance to the facility. The sign may also be included on an advance direction sign.

**TELEPHONE****F, 3****Colours:**

Border: None

Background: Green retro-reflective

Legend: White retro-reflective, Black semi-matt

The sign notifies drivers of the presence of a telephone.

The sign should be located at the facility. The sign may also be included on an advance direction sign.





FILLING STATION

F, 4

Colours:

Border: None

Background: Green retro-reflective

Legend: White retro-reflective, Black semi-matt

The sign notifies drivers of the presence of a filling station.

The sign should be located at the facility. The sign may also be included on an advance direction sign.



RESTUARANT

F, 6

Colours:

Border: None

Background: Green retro-reflective

Legend: White retro-reflective, Black semi-matt

The sign notifies drivers of the presence of a restaurant.

The sign should be located at the facility. The sign may also be included on an advance direction sign.

ADVANCE DIRECTION SIGN (MAP TYPE)

G, 1b

Colours:

Border: None

Background: Green retro-reflective

Legend: White retro-reflective

The map type advance direction sign is used to advise drivers of the layout of a road junction ahead. The arrow diagram represents the actual layout of the junction. The text on the sign indicates the destinations that can be reached by following the routes indicated. Route numbers may also be indicated on the sign before the destination name. The distance from the sign position to the turn can also be shown, normally in metres or kilometres.

The sign can be used to indicate the following type of junction: A high speed exit on an expressway or arterial road, a four legged junction, a staggered four legged junction, a traffic circle and a temporary detour.

The advance direction sign should be placed on the right hand side of the road at a distance of between 500 metres and one kilometre.

The following diagram is an example of a map-type advance direction sign in use in Southern Africa.

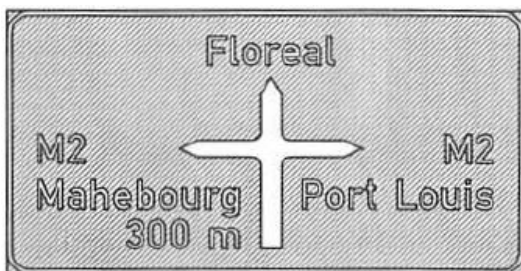



DIRECTION SIGN (FINGERBOARD)

G, 4b

Colours:

Border:	None
Background:	Green retro-reflective
Legend:	White retro-reflective

The direction sign “fingerboard” is shaped to form a point that acts as an arrow pointing towards the destination. The sign is normally used to direct drivers to minor destinations including facilities such as airports, railway stations, harbours, tourist destinations etc.

The sign is normally displayed on the right hand side of the road.

DIRECTION SIGN (STACK-TYPE - DIRECTION)

G, 5

Colours:

- Border: None
- Background: Green retro-reflective
- Legend: White retro-reflective

The stack- type direction sign is used to advise drivers of destinations that can be reached by following the routes indicated. Route numbers may also be indicated on the sign before the destination name. Each destination is indicated on a separate line or “stack”. If the layout of a junction is complex then a MAP-TYPE ADVANCE DIRECTION sign should preferably be used.

The sign should be placed on the right hand side of the road in advance of a junction at a distance depending on the operating speed at the junction, or at a junction.

The following diagram is an example of a stack-type direction sign in use in Southern Africa that can be placed in advance of a junction. Note that “hooked” arrows are used for an advance direction sign and the route number is included before the destination name.

G,5 (Advance):

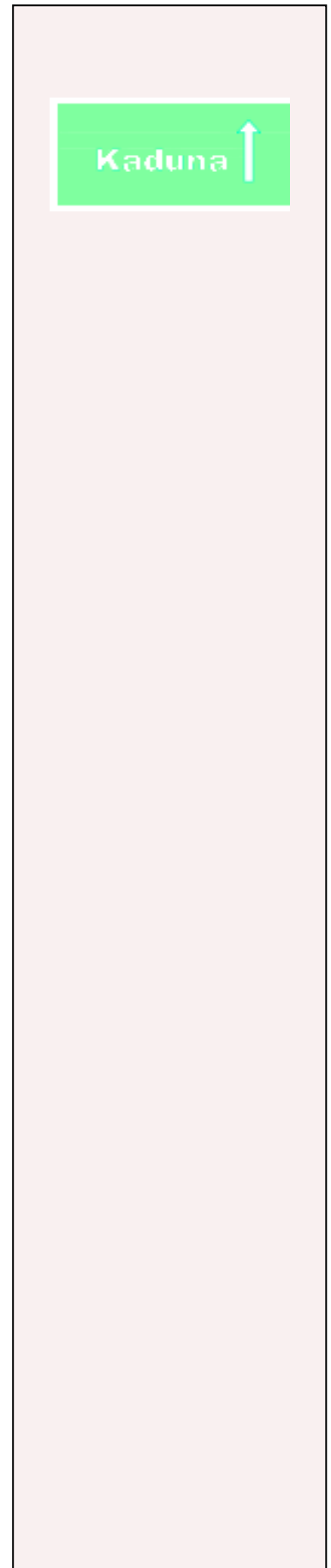
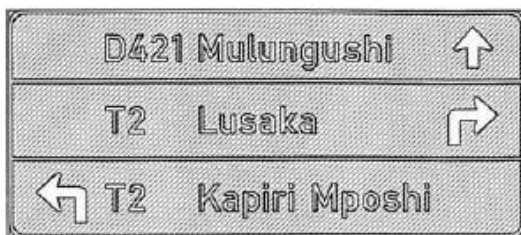

The following is an example of a stack-type direction sign in use in Southern Africa that can be placed at a junction. “Straight” arrows are used.

G5:



CONFIRMATION SIGN

G, 10

Colours:

Border:

Background: Green retro-reflective

Legend: White retro-reflective

The sign is normally used to confirm to drivers the distance to destinations on the current route.

The sign is normally displayed on the right hand side of the road downstream of a junction.

EXIT FROM A MOTORWAY**G, 22a G, 22b and G,22c****Colours:**

Border:

Background: Green retro-reflective

Legend: White retro-reflective

The sign is normally used to notify drivers of an exit from an expressway. The signs bear respectively one, two and three oblique bars.

The sign is displayed on the right hand side of the road at a distance of 300, 200 and 100 metres from the exit of the expressway.

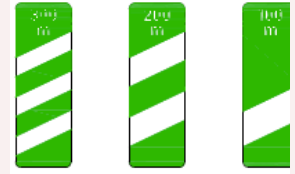
**STREET NAME SIGN****Colours:**

Border:

Background: Green retro-reflective

Legend: White retro-reflective

Street name signs are placed at intersections.



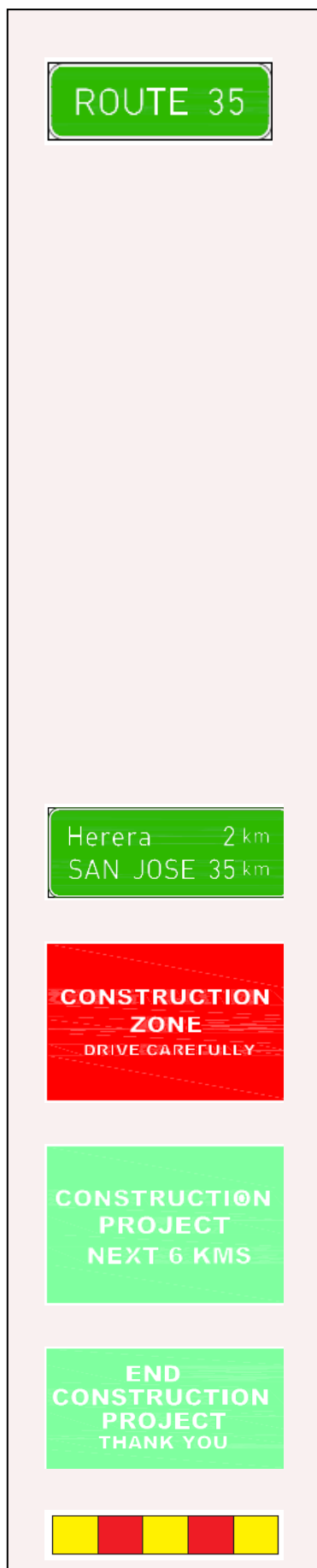

ROUTE SIGN

Colours:

Border:

Background: Green retro-reflective

Legend: White retro-reflective

Route signs are placed at intersections and other locations where confirmation of the route is required.

2.5 Temporary Road Signs

Temporary road signs should be provided for use on construction sites etc. as shown below.

TEMPORARY CONSTRUCTION SIGNS

Colours:

Border: none

Background: Green / red retro-reflective

Legend: White retro-reflective

The temporary construction sign is normally displayed on the right hand side of the road at the beginning or end of a construction zone.

The extent of road works should be clearly marked by setting up continuous barriers painted with alternate red and yellow or black and yellow stripes. Chevrons may also be used as shown in the diagram.

3 Road Markings

3.1 Introduction

Road markings make a vital contribution to safety by clearly defining the path to be followed through hazards, by separating conflicting movement and by directing the road edge on unlit roads at night. They can also improve junction capacity and make best use of space.

Road markings are used to regulate traffic, to warn or guide road-users. They may be used either alone or in conjunction with other signs or signals to emphasize or clarify their meaning. Road markings are defined as markings applied to or attached to the road surface as well as objects embedded in the road surface. The following are typical types of road markings:

- Longitudinal markings
- Transverse markings
- Arrow markings
- Oblique parallel lines (painted islands)
- Word markings
- Standing and parking regulations
- Markings on the carriageway or on adjacent structures

Road markings are usually classified as follows:

- Regulatory markings
- Warning markings
- Guidance markings
- Other delineation devices

The above is discussed in more detail below.

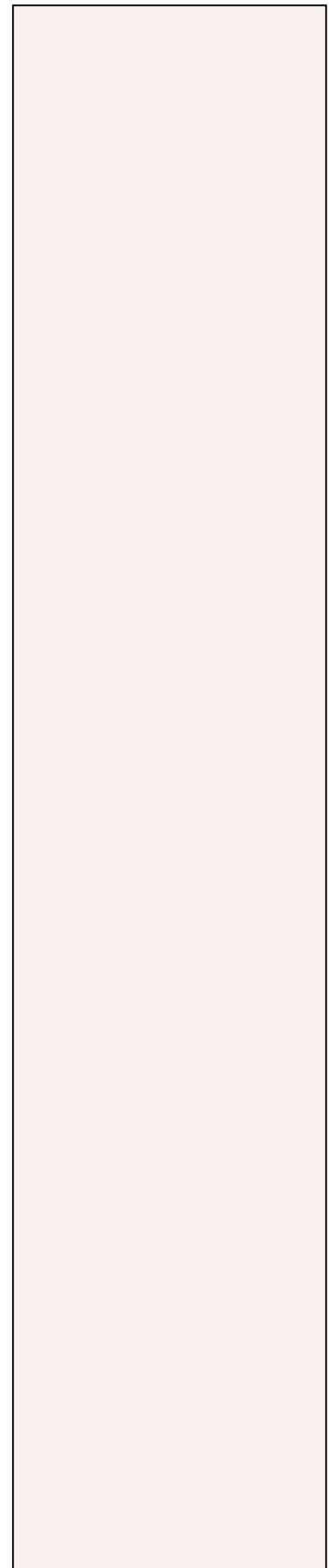

3.2 Stop and Yield Markings

3.2.1 Stop Lines

A Stop Line, when used in combination with a stop sign of a red traffic signal, requires that a driver of a vehicle shall stop immediately behind the Stop Line. The Stop Line should have the same meaning as a stop sign, if the stop sign is missing or damaged.

A Stop Line should be a continuous line of a minimum width of 300 millimetres in urban areas and 500 millimetres in rural areas. The line extends across the full width of the lane that is being used as the approach to a junction. In the case of a two way roadway, the Stop Line should extend from the no overtaking or no crossing line that is used to separate the two directions of travel to the kerb or edge of the carriageway. The Stop Line should be located not more than 15 metres or less than 1.2 metres from the line representing the continuation of the edge of the intersecting roadway depending on sight distance. When used with a pedestrian crossing at a junction the Stop Line should be positioned one metre in advance of the pedestrian crossing line. When used at a mid-block pedestrian crossing, the Stop Line should be positioned two metres in advance of the pedestrian crossing line.

It is recommended that the word STOP be painted on the road surface with a one metre spacing to the Stop Line.

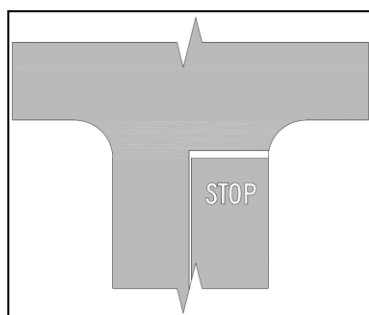

Figure 3.1: Stop Line

3.2.2 Yield Line (Give Way Line)

A Yield Line (Give Way Line) requires that traffic must yield the right of way at the point marked by the line to all traffic on the crossing road, rail traffic on a railway line crossing the road, and pedestrians or cyclists crossing the road on a pedestrian crossing. The Yield Line should have the same significance as a yield sign if the sign is missing or damaged.

The Yield Line is a broken line with a minimum width of 300 millimetres in urban areas and 500 millimetres in rural areas. The line extends across the full width of the lane that is being used as the approach to a junction. In the case of a two way roadway, the Yield Line should extend from the no overtaking or no crossing line that is used to separate the two directions of travel to the kerb or edge of the carriageway. A line to gap ratio of 2 to 1 should be used with the line being a recommended length of 600 millimetres and a 300 millimetre gap. These could be increased in rural areas to 1000 millimetres and 500 millimetres. The Yield Line should be located 1.2 metres from the line representing the continuation of the edge of the intersecting roadway depending on sight distance.

It is recommended that a yield triangle, with the apex facing the motorist, be painted on the road surface with one metre spacing to the Stop Line.

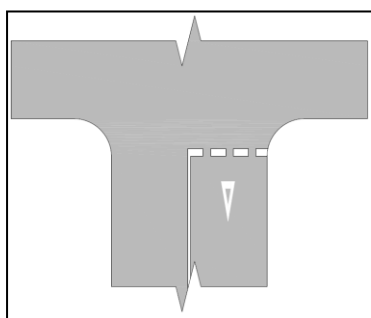

Figure 3.2: Yield Line

A yield marking is used to warn road users of a yield sign or yield line ahead.

The yield marking is a white triangular symbol painted metre in advance of a yield line. The length of the symbol should be in accordance with the Table 3.2.

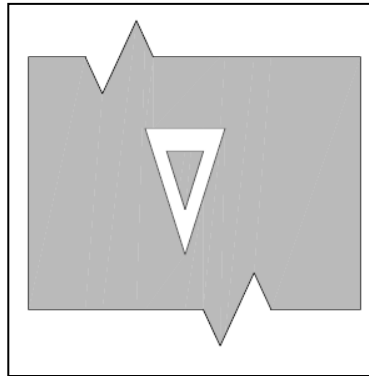

Figure 3.3: Yield Marking

Give way markings are generally intended for use at all junctions other than those controlled by STOP signs or traffic signals.

3.3 Longitudinal Markings

3.3.1 Dividing Lines (Centre Line)

A Dividing Line is used to demarcate the centreline of a two way road carrying traffic in opposite directions and should not be confused with a Lane Line that is used to demarcate traffic lanes on a multi-lane road. Traffic should only cross the dividing line when safe to do so. The Dividing Line should be 100 millimetres in width and 150 millimetres on multi-lane highways.

The marking should be used only on single carriageway roads. Where the road comprises one lane in each direction, the 100 millimetre wide marking will normally be sufficient. On four-lane roads, three-lanes marked as two in one direction and one in the

other or two-lane 10 metres wide, the 150 millimetre marking should be used.

A Dividing line comprises a broken white line with a line-to-gap ratio as shown in Table 3.1:

Table 3.1: Module Dimension for Dividing Line

Road Class	Line-to Gap Ratio	Module Width (m)	Line Length (m)	Gap Length (m)
Rural	1 to 2	12	4	8
Urban	1 to 2	9	3	6
Urban (>80 km/hr)	1 to 2	12	4	8

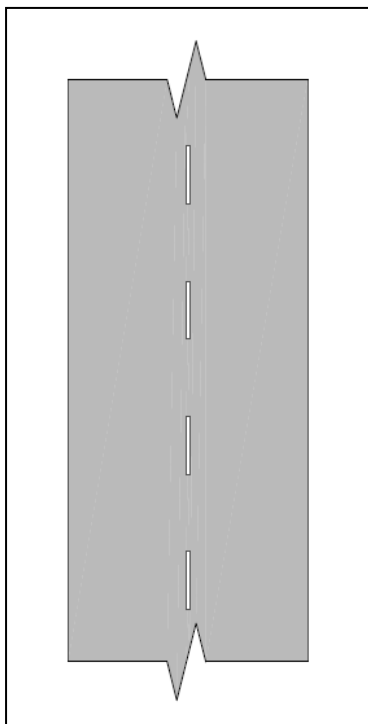
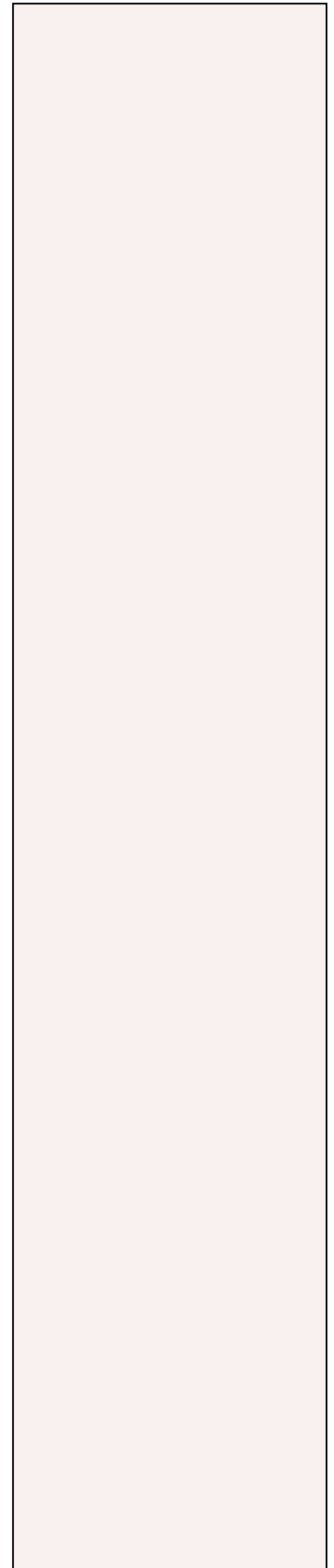

Figure 3.4: Dividing Line



3.3.2 Traffic Lane Lines

Traffic lane lines are used demarcate traffic lanes for vehicles travelling on a portion of roadway in the same direction. The traffic lane lines are normally 100 millimetres in width and are white in colour. Traffic lane lines normally consist of a broken line with strokes of equal length separated by uniform gaps. The length of the lines and gaps depends on the class of the road and the application of the line. The traffic lane line is used on multi-lane roads carrying traffic in the same direction.

Lane lines should be parallel to the centreline and should be synchronised across the carriageway.

The Lane Line comprises a broken white line with a line-to-gap ratio as shown in Table 3.2:

Table 3.2: Module Dimension for Lane Line

Road Class	Line-to Gap Ratio	Module Width (m)	Line Length (m)	Gap Length (m)
Expressways and Rural (>80 km/hr)	1 to 2	6	2	4
Urban (<80 km/hr)	1 to 2	4.5	1.5	3
Urban (>80 km/hr)	1 to 2	6	2	4

If an increased level of warning is needed, a gap to line ratio of 1 to 1 with dimensions of 1.5 metres to 1.5 metres.

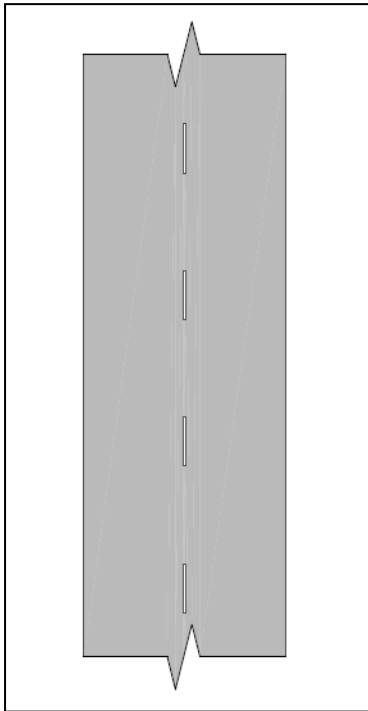
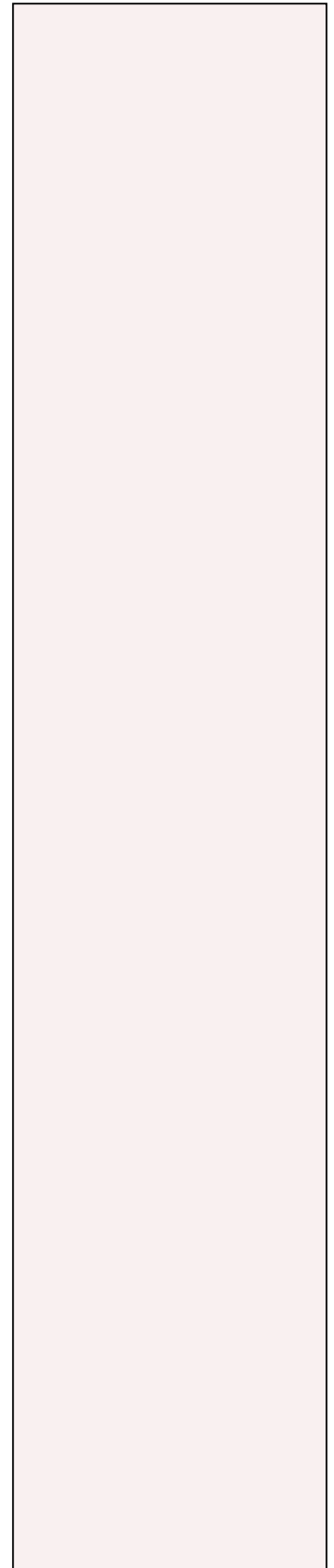

Figure 3.5: Traffic Lane Lines

3.3.3 Continuity Line (Warning Line)

A Continuity Line indicates that the road will shortly deviate from the through line e.g. in place of a lane line to warn road users that if they are travelling on the left, on the left side of the roadway, or right, on the right side of the roadway and continuity line, that portion of road will shortly deviate from the through roadway e.g. at a dedicated left turn lane.

The line comprises a broken white line with a thickness of at least 200 millimetres and 300 millimetres on expressways, with a gap to line ratio of 1 to 2 and dimensions of 1.5 metres to 3 metres, or if an increased level of warning is needed a gap to line ratio of 1 to 1 with dimensions of 1.5 metres to 1.5metres.



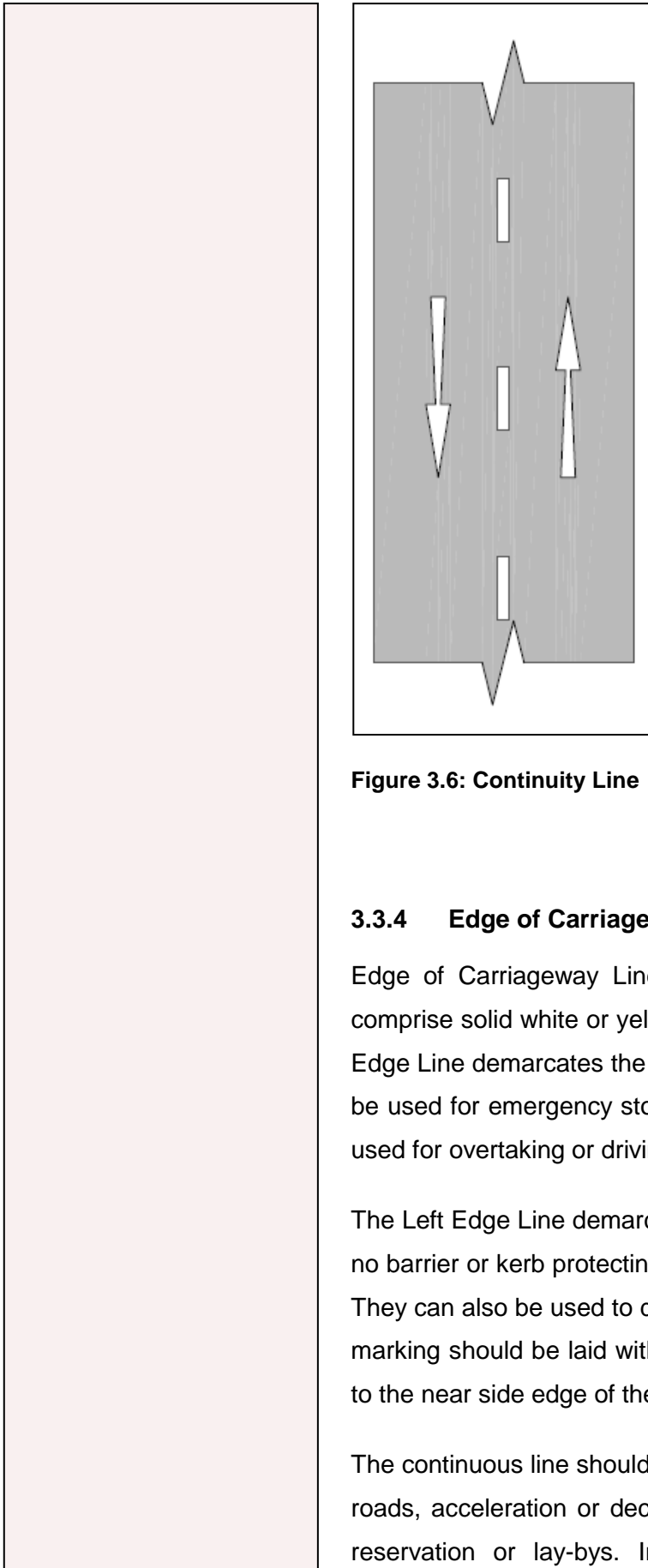

Figure 3.6: Continuity Line

3.3.4 Edge of Carriageway Lines

Edge of Carriageway Lines located on the left and right edges comprise solid white or yellow lines 100 millimetres wide. The Right Edge Line demarcates the edge of the right hand shoulder that is to be used for emergency stops. The right hand shoulder shall not be used for overtaking or driving.

The Left Edge Line demarcated the edge of the road where there is no barrier or kerb protecting the median between two carriageways. They can also be used to delineate footways at level crossings. The marking should be laid with a gap of approximately 225 millimetres to the near side edge of the carriageway.

The continuous line should not be carried across the mouths of side roads, acceleration or deceleration splays and gaps in the central reservation or lay-bys. In these locations a broken line, 600

millimetres long with 300 millimetre gaps or 1 000 millimetres long with 1 000 millimetre gaps (at acceleration /deceleration zones and at lane drops) should be used.

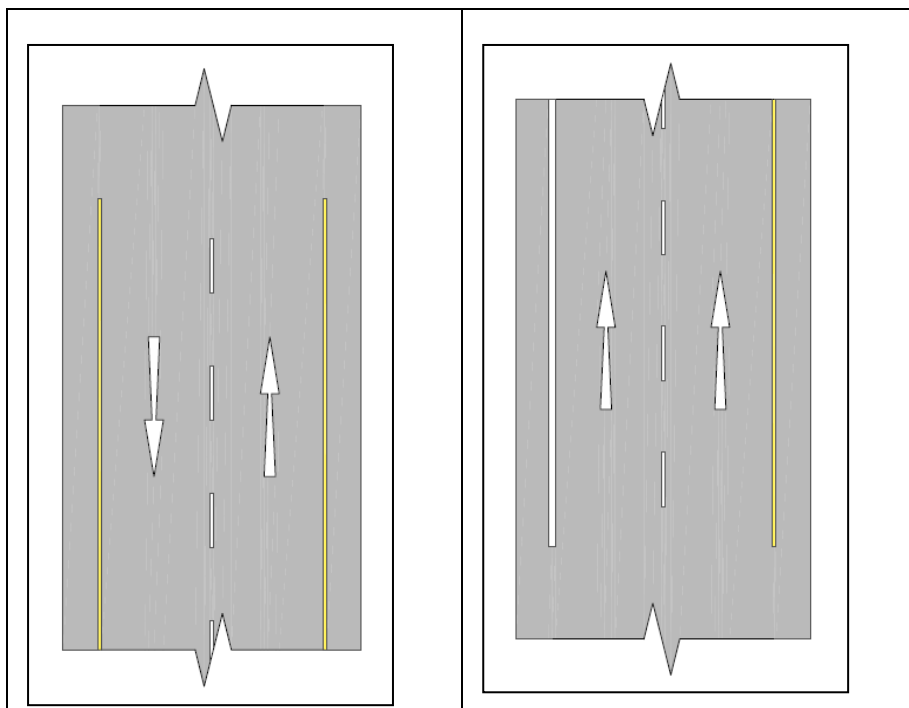

Figure 3.7: Left Edge / Right Edge Lines

3.3.5 Painted Traffic Islands

A painted traffic island consists of painted white lines 100 millimetres in width that forms a boundary to the painted island. The boundary of the painted island may be formed by a kerb on one side, in which case a painted line is not necessary. Within the boundary the area should be painted with yellow bar lines in a diagonal pattern. The lines should be a minimum of 150 millimetres in width and a maximum of 1 000 millimetres on an Expressway. The ratio of the bar width to the spaces between the bars is 1 to 2. The painted bars should slope forward at an angle of 30° to the centreline of the road in the direction of travel.

Painted islands can be used in the following situations:

- in advance of pedestrian refuge islands on two-way roadways;
- in advance of the start of a median island;
- in advance of channelizing kerbed islands;
- at freeway off-ramp gores;
- at freeway on-ramp gores following 180° to 360° loop ramps;
- as a separator island between opposing flows of traffic when there is insufficient space for a median island or barrier;
- as a channelizing device to prevent straight through traffic entering a turning lane which is in line across a junction from a similar lane serving turning traffic in the opposite direction;
- as a "shadow" island next to a kerbed island to control general traffic movement but allow overrunning by extra-large vehicles.

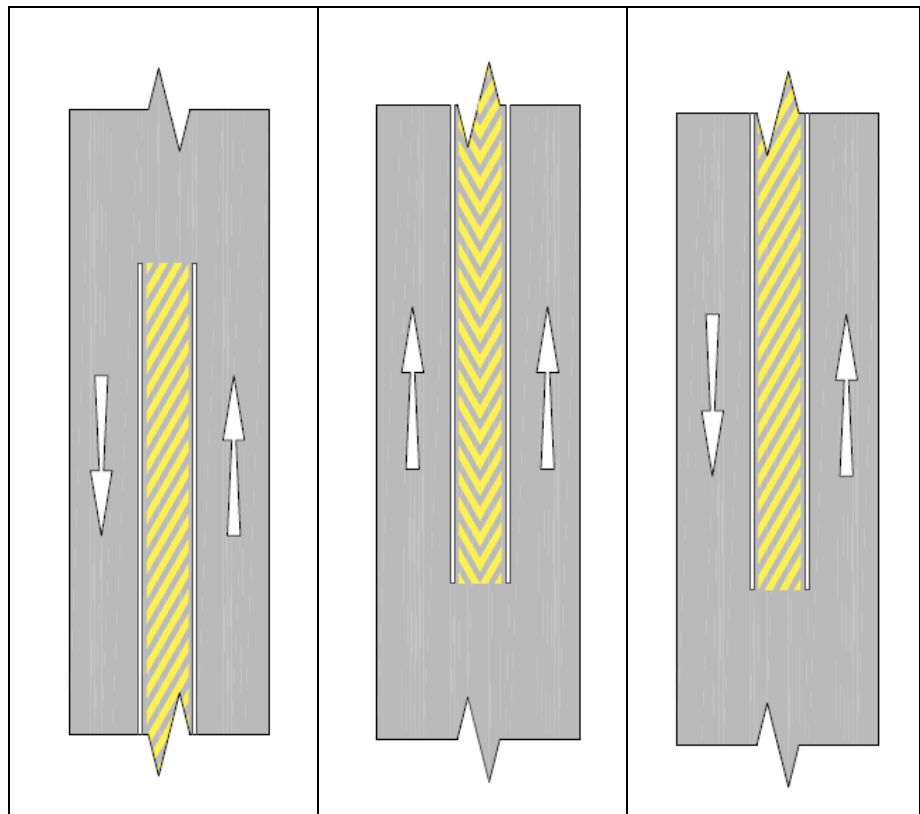

Figure 3.8: Painted Island

3.3.6 Exclusive Use Lane

An exclusive use lane indicates that vehicles may not drive or park in a lane that is reserved for the exclusive use of a particular class of vehicle e.g. cycle, bus etc.

The lane is marked with a broken yellow line with a minimum width of 150 millimetres with a gap ratio of 1 to 1 with line and gap lengths of 750 millimetres. A specific symbol is usually marked in the lane indicating the class of vehicle that can use the lane. The length of the symbol should be in accordance with Table 3.2.

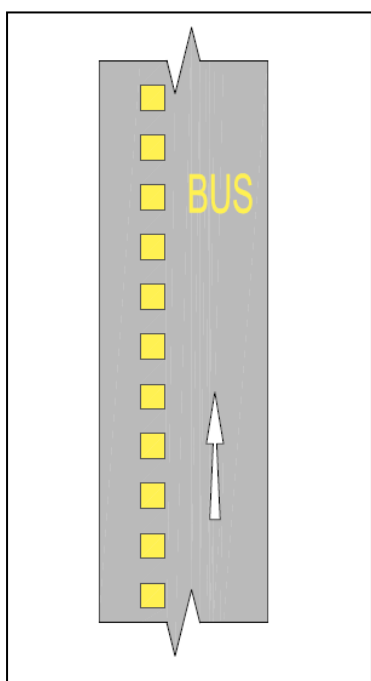

Figure 3.9: Exclusive Lane

3.4 Double White Lines

3.4.1 No Overtaking Lines

A No Overtaking Line is a continuous or unbroken white solid centre line usually used at places where sight distance is restricted such as a hill crest or bend in the carriageway or if the carriageway is narrow. The No Overtaking Line can be used to the right or in place of a Dividing Line. The application of the No Overtaking Line

in both directions according to sight distance may result in a section of No Crossing Line. Refer to Figure 3.10: No Overtaking Lines for Vertical Curves below.

A continuous length of double white line, with any number of changes between continuous and broken Dividing Line, comprises a system.

A longitudinal marking consisting of a continuous line (“no overtaking line”) on the carriageway shall mean that vehicles are not permitted to cross or straddle that line when it is used to the right or in place of a broken Dividing Line (Centre Line). When the line separates the two directions of traffic, the vehicles are not permitted to travel on that side of the line which, for the driver, is opposite to the edge of the carriageway appropriate to the direction of traffic. A longitudinal marking consisting of two continuous lines shall have the same meaning.

The continuous no overtaking line is used to separate traffic on a road that is travelling in opposite directions. If it is necessary to prevent traffic from changing lanes on a multi-lane road with two or more lanes in one direction, then a channelization continuous line can be used. The application of the lines in this case is the same as for a no overtaking line.

The two lines are normally spaced 175 millimetres apart (Min. 90 millimetres) each line be a minimum of 100 millimetres wide and 150 millimetres maximum. The overall maximum width of both line and the gap between then must not exceed 900 millimetres. If one of the lines is broken it comprised one metre marks with five metre gaps.

The no overtaking line should be marked where the barrier sight distance between a point 1.05 metre high (eye height) and a point 1.3 metre high (equivalent vehicle height) on a vertical or horizontal curve is less than the values given in Table 3.3:

Table 3.3: Barrier Sight Distance for No Overtaking Line

Design Speed: km/hr	Minimum Barrier Sight Distance (m)
50	150
60	180
80	250
100	300
120	400

The length of the no overtaking line depends on the application of the minimum barrier sight distance as shown in the following figures for a vertical curve application and the horizontal curve respectively.

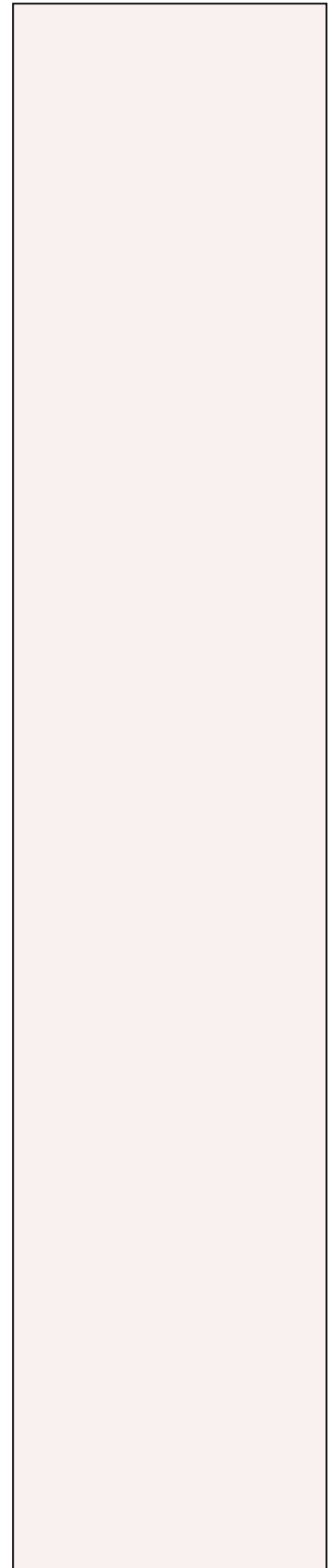

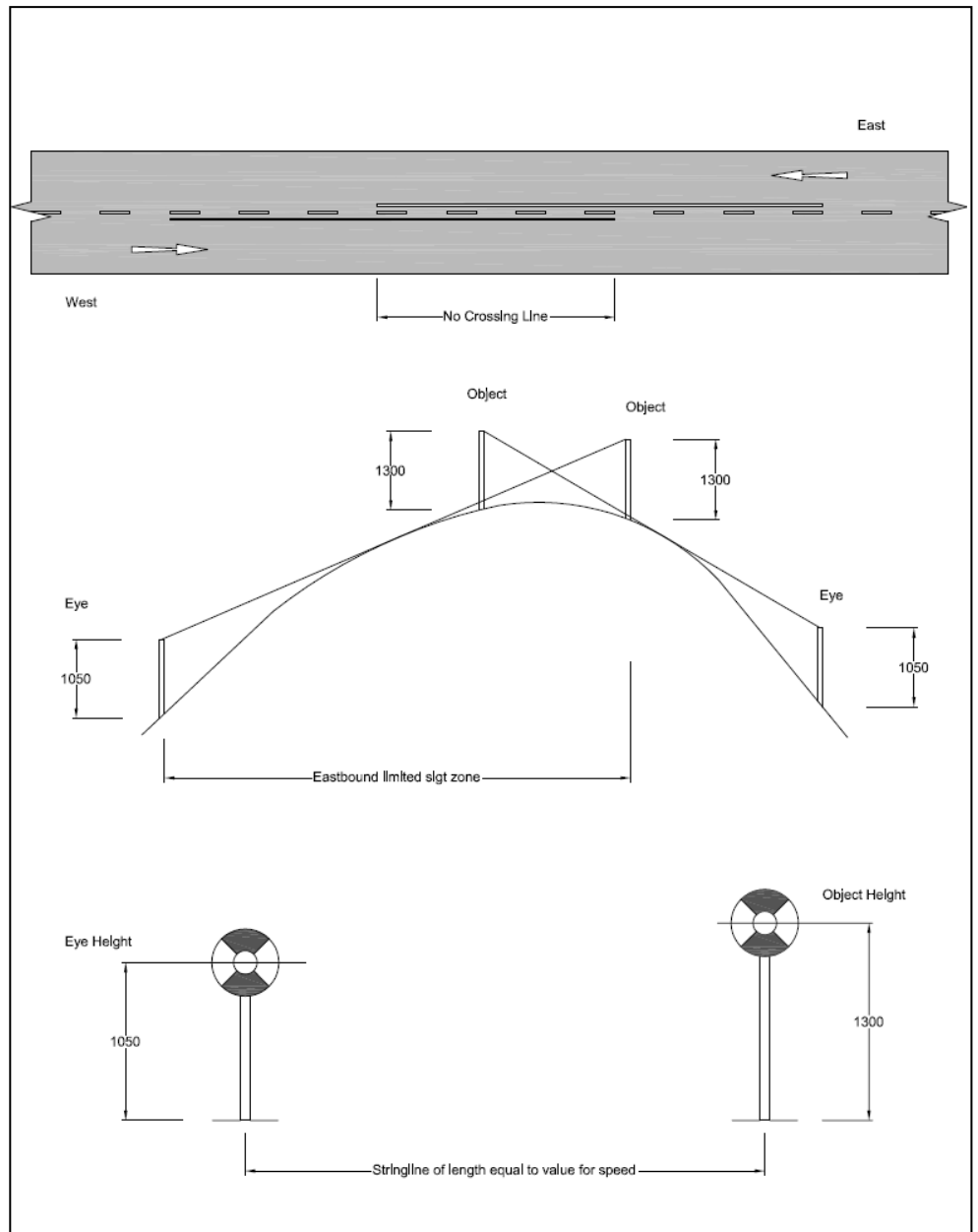

Figure 3.10: No Overtaking Lines for Vertical Curves

Notes:

1. Note that the application of a no overtaking line in both directions can result in a section of no crossing line.
2. The application of the above figure should be carried out for vertical and horizontal curves at the same time. The recommended minimum distance between successive lengths of no overtaking or no crossing lines is 120 metres and is applied irrespective of whether the lines are in the same direction or opposite directions.

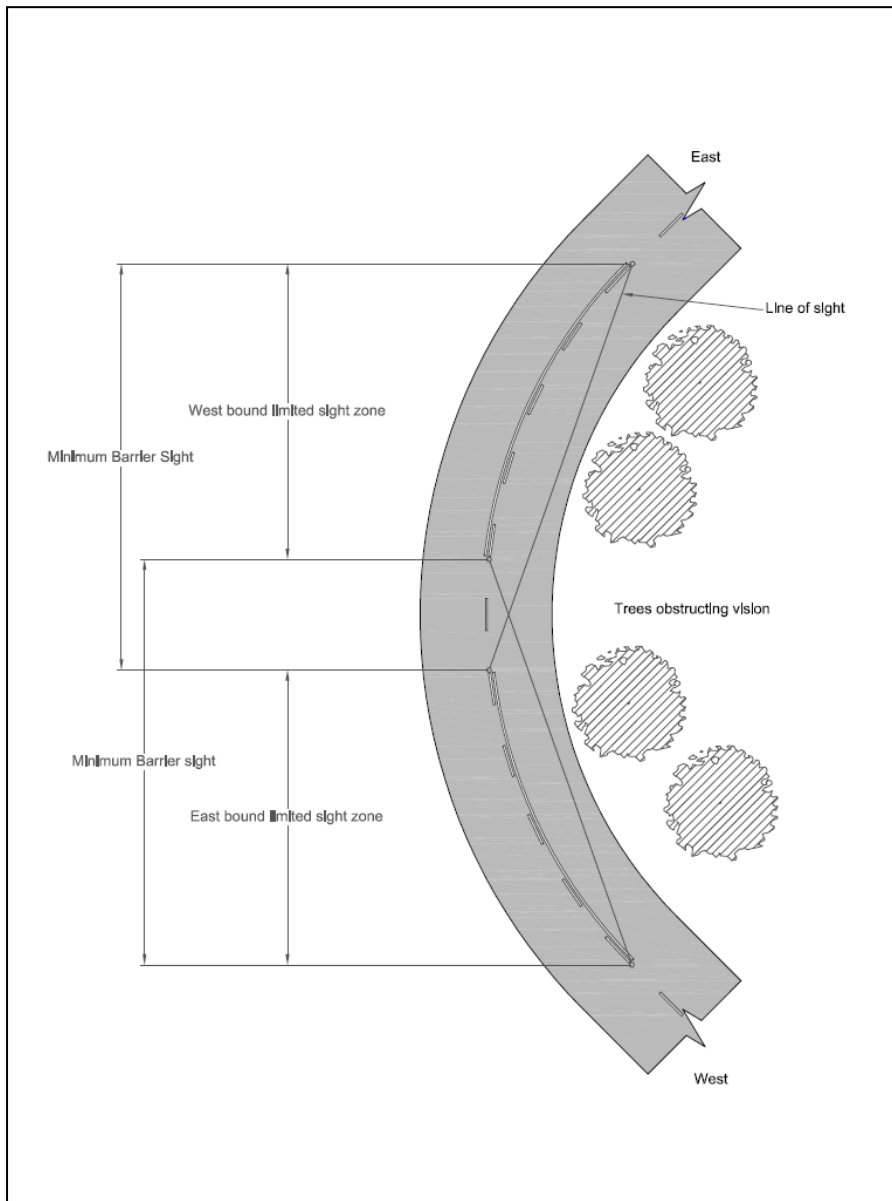
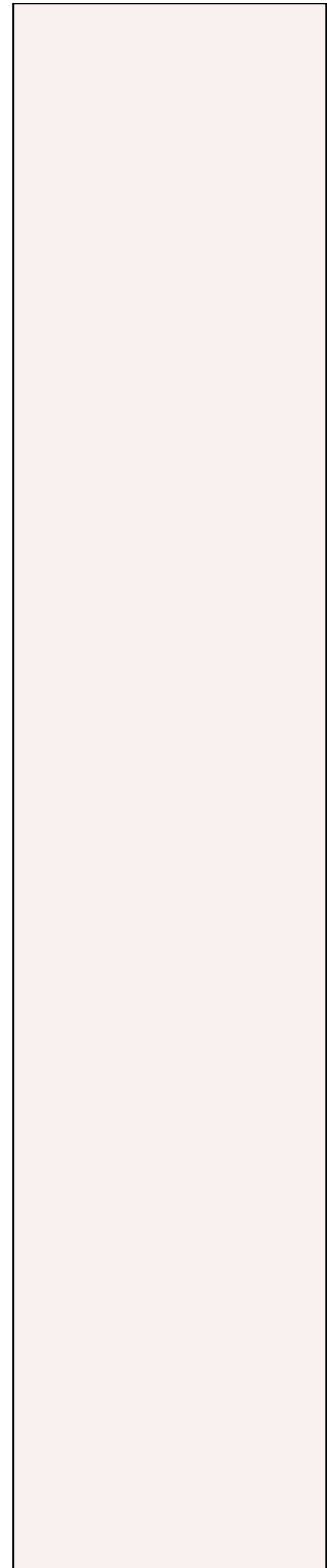

Figure 3.11: No Overtaking Lines for Horizontal Curves



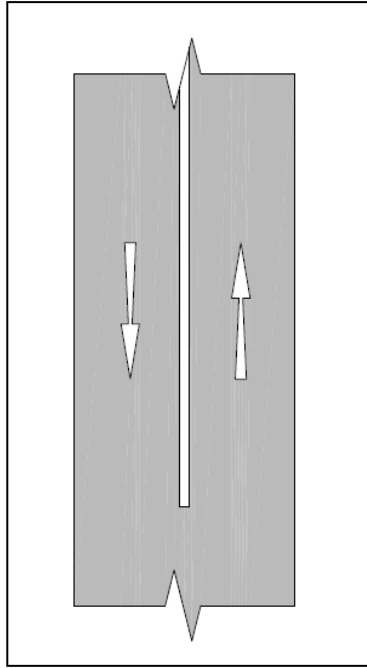

Figure 3.12: No Overtaking Line

3.4.2 No Crossing Line

A No Crossing Line requires that a vehicle shall not drive to the left of the line or physically cross the line, unless there is an obstruction and it is safe to pass.

The No Crossing Line is two continuous white lines each of 100 millimetre width (double white lines). The lines are separated by a gap of a minimum of 50 millimetres without road studs to 400 millimetres to accommodate a Dividing Line and two rows of road studs. The gap between the dividing line and the No Crossing Line is 50 millimetres.

No Crossing Lines can be used to prevent left turns onto property driveways.

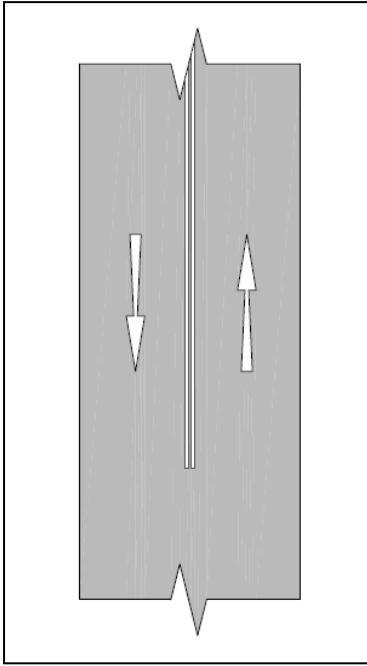

Figure 3.13: No Crossing Line

3.4.3 Channelizing Line

A Channelizing Line is a road marking used at junctions to separate multi-lane traffic and prohibits lane changing in the immediate vicinity of a junction.

The Channelizing line width can range from 100 millimetres when used as a stacking lane marking at an intersection, to 200 millimetres when used as an edge line to a painted traffic island. The recommended length of a Channelizing Line is 30 metres at an urban intersection. On roads with an operating speed of 80km/hr or greater, the width should be increased to 300 millimetres and the length to 60 metres.

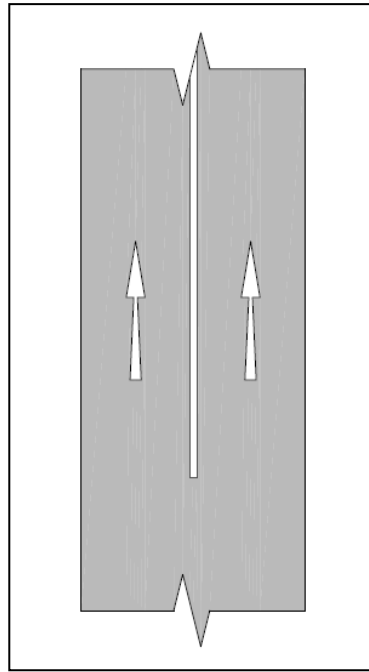

Figure 3.14: Channelizing Line

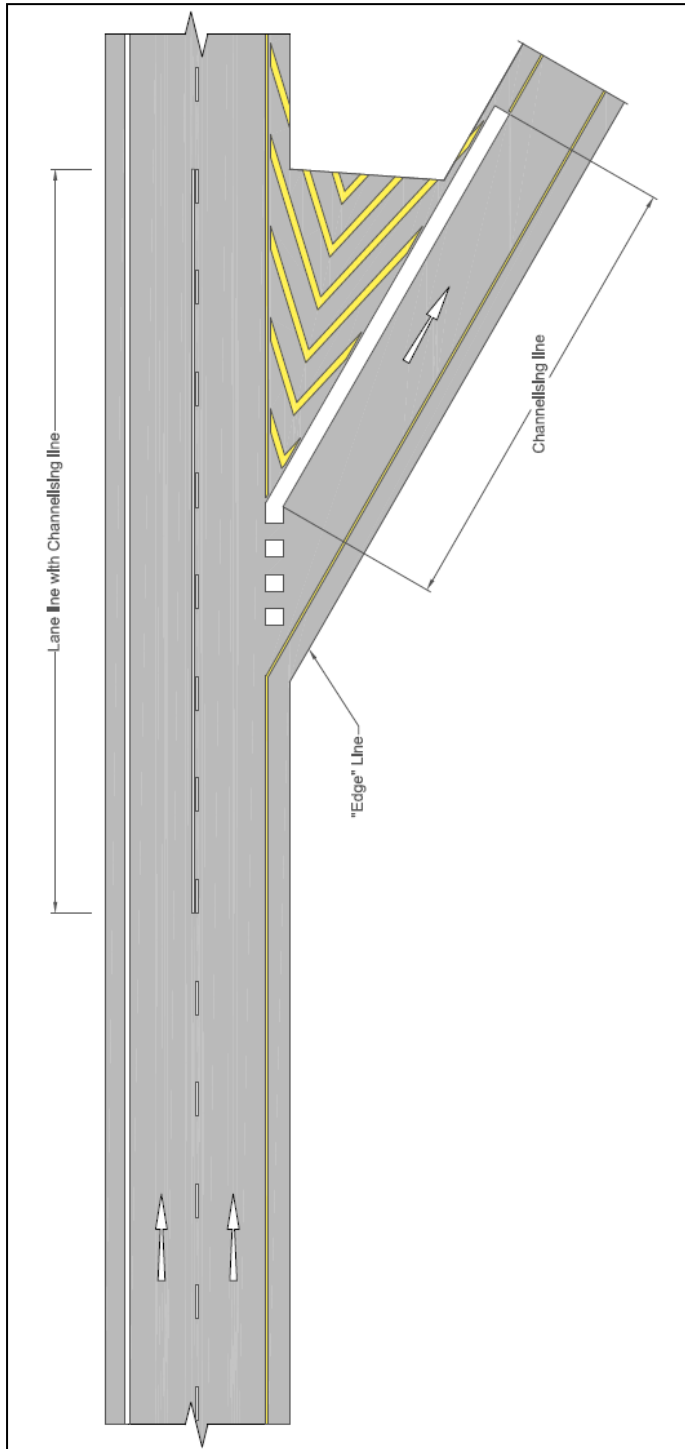
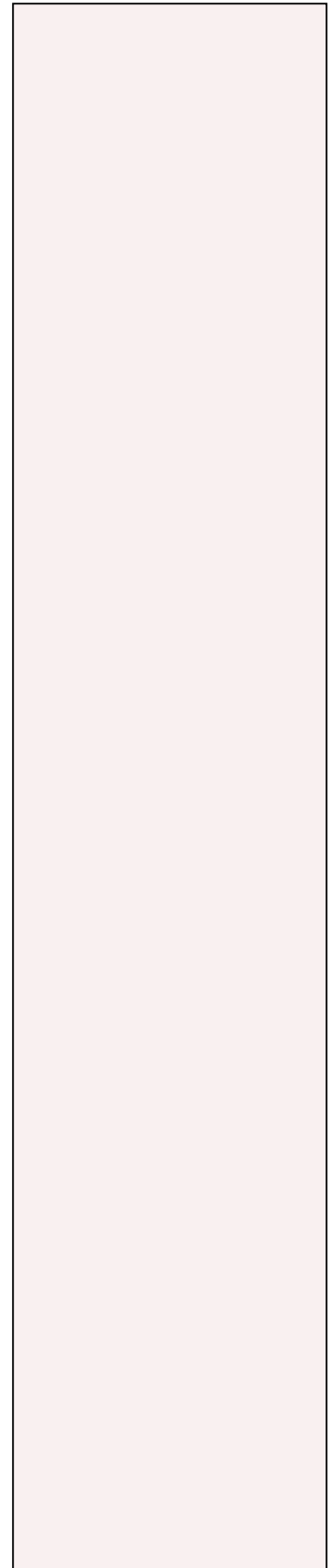

Figure 3.15: Typical Channelizing line at an Exit Ramp



3.5 Other Delineation Devices

3.5.1 Road studs (“Cats Eyes”)

Road studs or more commonly known “cats eyes” are devices incorporating retro-reflective lenses that efficiently reflect the beams of vehicles headlights. They are commonly used in combination with road markings in situations where there may be poor visibility.

Road studs can be applied in different colours, commonly red, yellow and white. In some countries the following meanings are conveyed:

- Red - means Prohibition
- Yellow - means Warning
- White – means Guidance

Situations where road studs may be warranted include:

- Areas where there is regular mist, fog or rain resulting in reduced visibility
- Heavy traffic volumes resulting in glare and poor visibility due to traffic density e.g. trucks
- Poor road design standards e.g. sharp curves, narrow roads
- High accident zones such as intersections, complex road layouts and sharp curves
- Construction zones with temporary deviations.

Road studs are placed centrally in the gaps between broken lines or next to a continuous line with a 50 millimetre gap between the line and the road stud. Road studs should be spaced to fall on a common cross section across the road. The recommended longitudinal spacing is:

- Rural roads: 24 metres
- Urban 18 metres

- Temporary: 12 metres

In abnormal situations the spacing can be reduced to three metres.

3.5.2 Guardrail (Crash barrier) Delineators

Guardrail delineators are retro-reflective devices used to warn road users of the presence of a guardrail.

The delineators should be at least 70 cm² and should be attached to the guardrail at regular intervals.

3.6 Intersections

3.6.1 Guide Lines

Guide Lines are used to give guidance to motorists within a junction.

A guide line is a broken white line with a width of 100 millimetres and a gap to line ratio of 1 to 3 with dimensions of 500 millimetres to 1.5 metres.

Guidelines can be used to provide straight through guidance, turning guidance or by means of parallel lines and guidance to pedestrians wanting to cross a road. E.g. for left turning traffic at a dual carriageway intersection, the guide line indicates the most efficient turning path to follow. This is particularly useful when there is more than one turning lane.

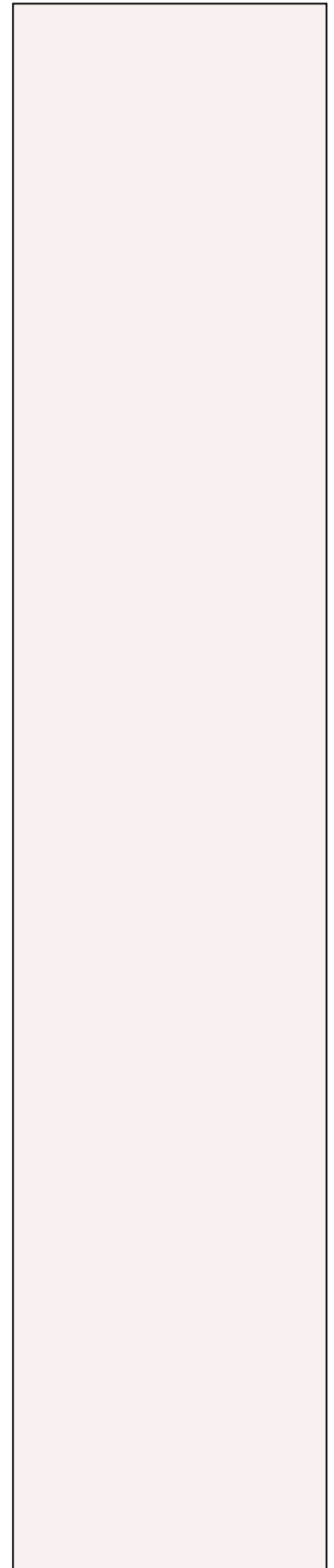

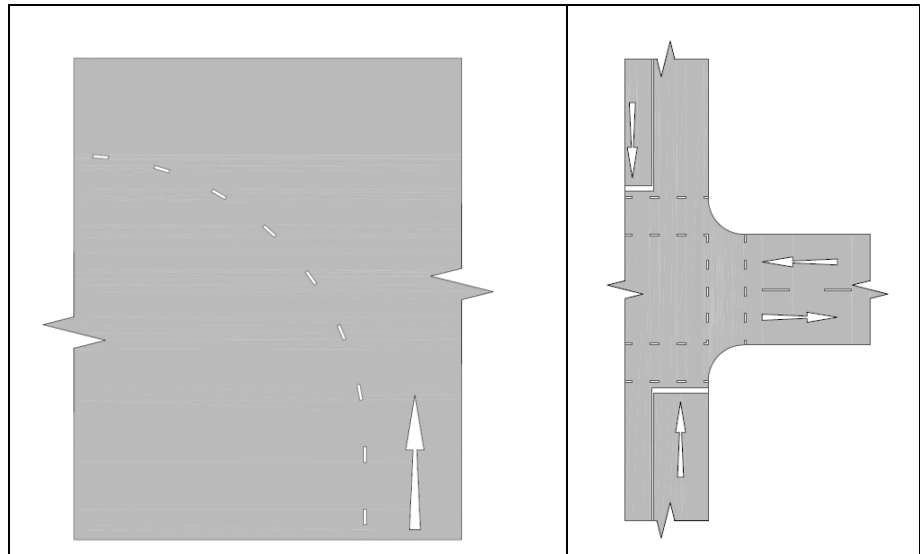

Figure 3.16: Guide Lines

3.6.2 Traffic Circle Arrows

Traffic circle arrows indicate that it is a mandatory requirement that drivers shall proceed only in the direction of the arrows. When a channelizing island is provided or a painted island is provided, drivers may not pass to the left of it nor drive over the island. A minimum diameter island of between two and six metres is recommended.

Three yellow arrows shall be painted on the road surface to indicate the direction of travel. The arrows can vary from five to seven metres in length depending on the size of the island.

3.7 Direction Arrows and Lane Destinations

3.7.1 Direction Arrows

Arrow markings are provided on roads that have more than one lane separating vehicles on the approach to an intersection and are used to indicate which lane traffic should use to perform a particular movement (straight, left or right). The arrows should be white in

colour. Arrows can also be used on one way roads to indicate the direction of traffic.

At a junction the first arrow should be placed 1 metre before a stop or yield line or if the word STOP or a Yield sign is used, 1 metre before such marking. This distance can be increased to 15 metres to 25 metres. Subsequent arrows should be spaced at 30 metres to 40 metres. On high speed roads these distances can be increased up to 1.5 times. Two or more arrows should be used if there is sufficient space. The length of the arrows should be in accordance with the recommendations in Table 3.4.

Table 3.4: Recommended Symbol Lengths

Design Speed: km/hr	Typical Applications	Recommended Length for Arrows, Symbols, Letters (m)
30 - 40	City Centre	1.25 or 2.5
50 - 60	Urban	2.5 or 4.0
70 - 90	Urban Arterial / Rural Expressway	4.0 or 5.0
100 - 120	Rural Roads and Expressways	5.0

Source: (Department of Transport, South Africa, May 2012)

The recommended shape of the arrows should be in accordance with the following template.

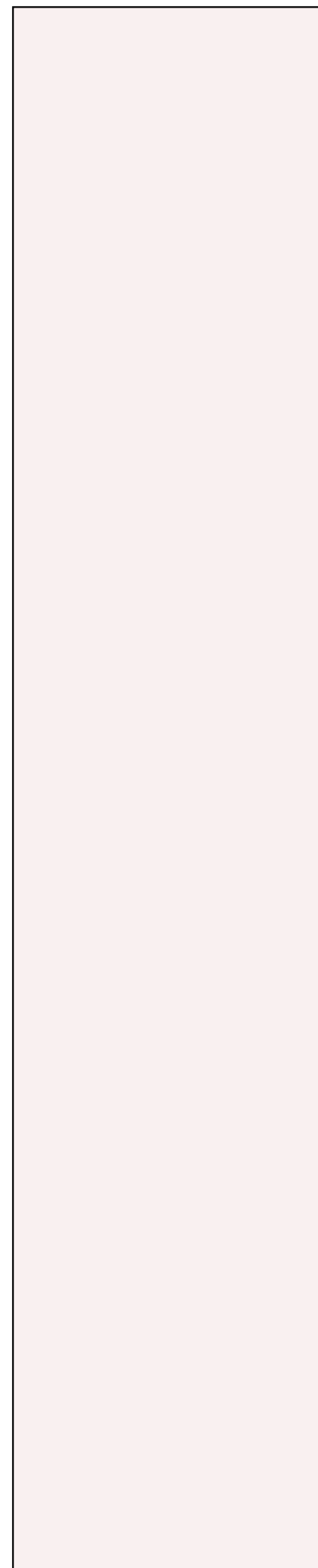

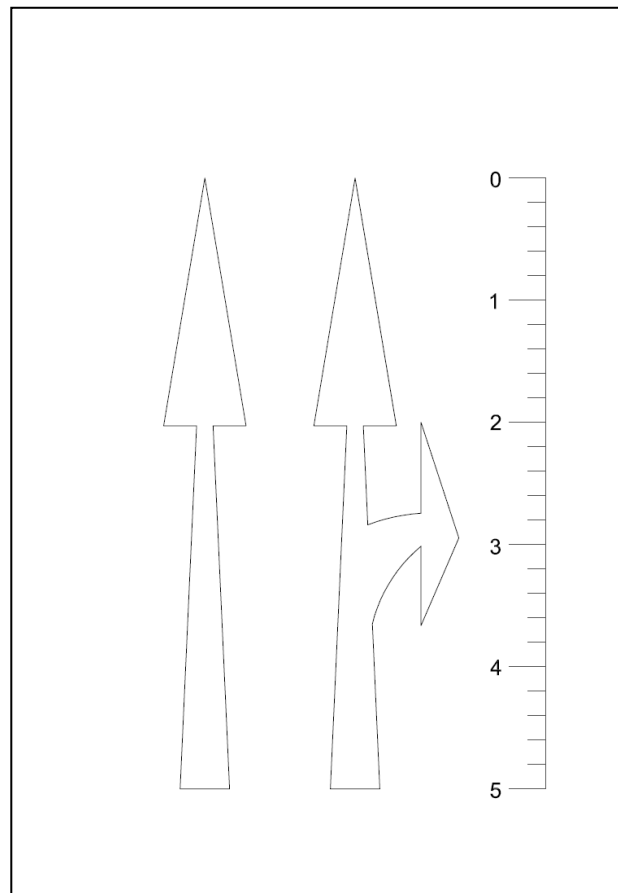

Figure 3.17: Arrow Marking Template

3.8 Warning Markings

3.8.1 Word Markings

Word markings are intended to give guidance to road users and to reinforce the messages given on road signs e.g. “KEEP RIGHT”, “ONLY”, or destination abbreviations.

Word Markings comprise white letters or numerals the letter height of which is in accordance with Table 3.4 above.

Then skid hazard caused by excessive paint on the road surface should be considered.

The following diagram provides guidance as to the shape of the STOP marking.

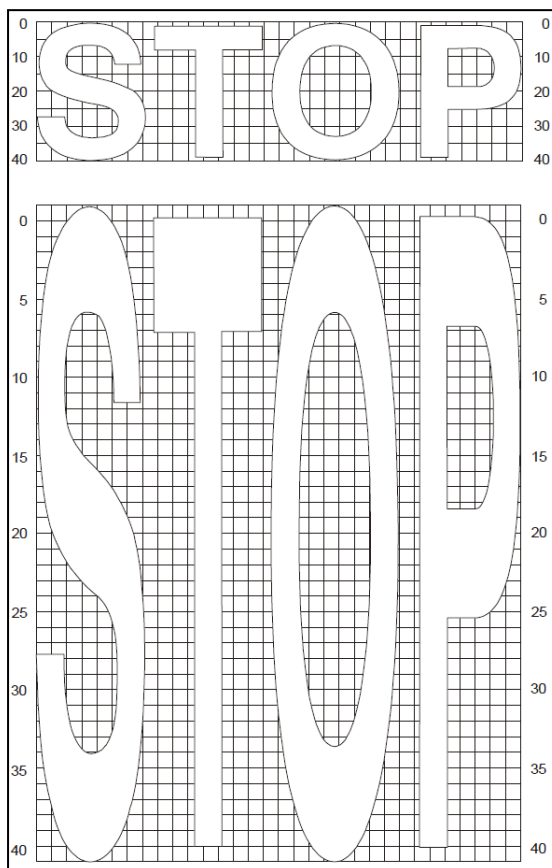

Figure 3.18: Template for Word Marking

3.9 Pedestrian Crossings

3.9.1 Pedestrian Crossings

Pedestrian crossing lines or block pedestrian crossing markings (“Zebra” crossings) require that motorists slow down and yield or stop to allow a pedestrian that is on the crossing or waiting, to cross the road. At the same time a pedestrian may only cross the road at a marked crossing if it is provided.

Pedestrian crossing lines are two parallel continuous white lines 100 millimetres wide and spaced at least 2.4 metres to three metres apart. Pedestrian crossing lines can be used at a traffic signal or at midblock locations. They should be preceded by a stop line when used at a traffic signal and a yield line when used at midblock locations controlled by a road sign. They should be preceded by a

pedestrian crossing sign. At midblock locations, they may be used in combination with a block pedestrian crossing that is more visible.

Block pedestrian crossings are more visible than pedestrian crossing lines and comprise rectangular painted markings of minimum length 2.4 metres and a minimum width of 500 millimetres, and maximum width of 750 millimetres spaced 600 millimetres apart. In exceptional cases, the minimum width can be reduced to 380 millimetres and maximum can be increased to 840 millimetres. They extend across the full width of the roadway. They should be preceded by a stop line when used at a traffic signal and a yield line when used at midblock locations controlled by a road sign.

The yield line consists of a single broken line comprising 500 millimetre marks and 500 millimetre gaps, and is 200 millimetres wide. It is normally sited between 1.1 metres and three metres from the edge of the stripes on the crossing, whether or not studs are used, and must extend across the full width of the carriageway. This three metre limit may be increased up to 10 metres if necessary.

Pedestrian crossings should only be marked at locations where there is adequate sight distance.

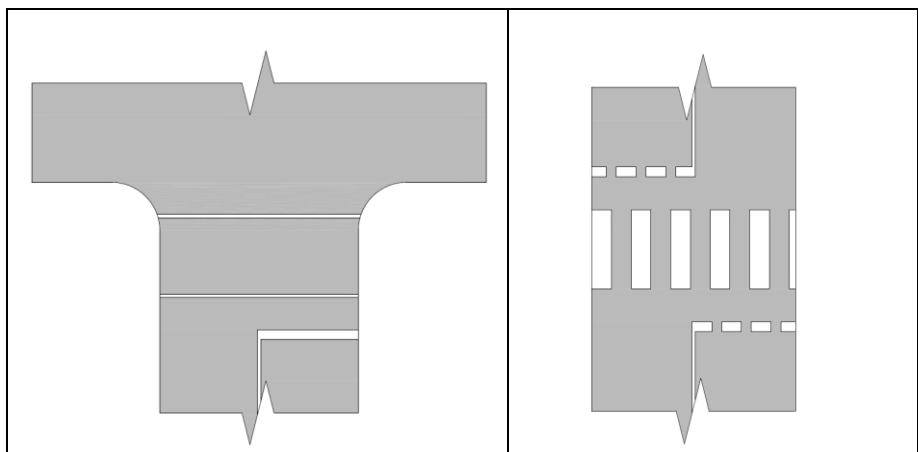

Figure 3.19: Pedestrian Crossing

3.10 Parking

3.10.1 Parking Bays

Parking Bay lines require that a vehicle must be parked within the lines and within 150 millimetres from a kerb if one is provided.

The Parking Bay lines are white lines 100 millimetres wide and the configuration varies according to whether the lines are for parallel parking or angled parking. The minimum line marking for a parking bay is a 600 millimetre line extending from the outer limit of the parking bay towards the kerb, depending on the angle of the bay with a 600 millimetre line forming a “T” with this line. The recommended dimensions of a standard parking bay are five metres by 2.5 metres. The length should be extended to six metres for parallel kerbside bays.

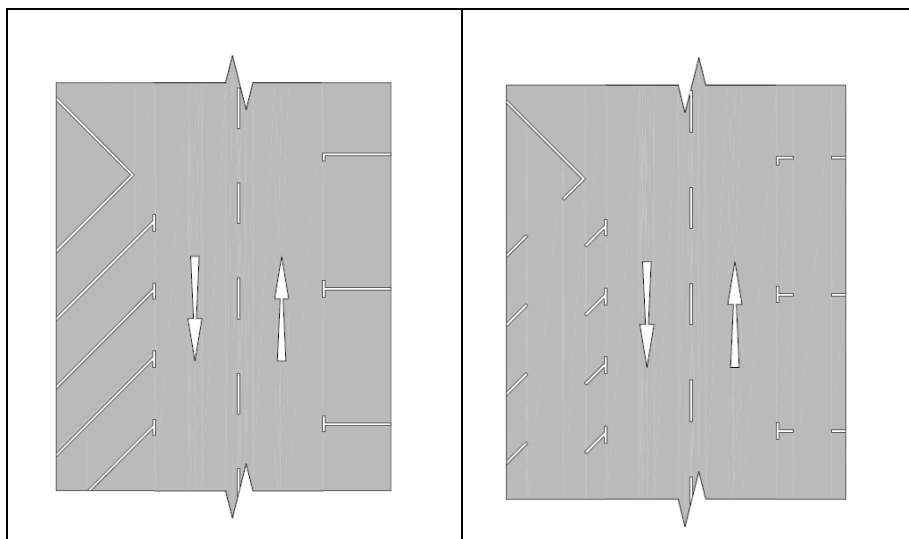
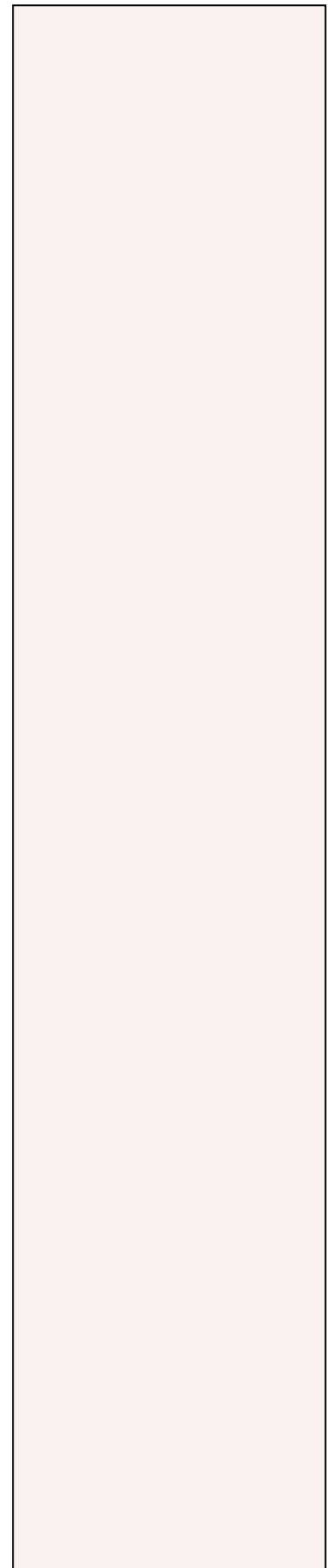

Figure 3.20: Parking Bays



4 Traffic Signals

4.1 Introduction

Traffic signals are standardised devices for the regulation and control of vehicular traffic, pedestrians and pedal cyclists. They are normally used at the following locations:

- Signalised intersections
- Signalised pedestrian and cyclist crossings
- Control of public transport lanes
- Temporary road works
- Railway crossings

Traffic signals are complex in terms of their design, installation and operation and should only be undertaken by qualified persons with a high level of skill and experience. A typical traffic signal design should comprise of the following information:

- A scale drawing of the intersection to be signalized showing the road layout and traffic lanes
- The number, type and location of the traffic signal faces
- Pedestrian and cyclist facilities
- Traffic signal phasing, timing plans and offsets (to achieve synchronization of traffic signals at consecutive intersections)
- Date of implementation and signature of approval of a competent, suitable qualified person

The main objectives of traffic signals are as follows:

- To reduce conflicts between vehicles and other traffic (pedestrians and cyclists)
- To enable pedestrians and cyclists to cross the road safely
- To improve the capacity of an intersection

- To improve safety
- To reduce delays to side road traffic
- To provide for continuity of movement along a route
- To warn of hazards

The provision of traffic signals is not always the best solution to a particular situation and the following alternatives should also be considered:

- Redesign the geometry of the intersection to improve traffic flow and safety e.g. the provision of a dedicated left turn lane for turning traffic
- The provision of a traffic circle
- The provision of an interchange if there are high volumes of traffic
- The introduction of traffic management measures such as one way streets, road closures and the banning of certain turning movements
- The introduction of traffic calming

A possible disadvantage of traffic signals is that they may only be needed during the peak traffic flow hours. During off peak hours when traffic flows are lower, the signal may create unnecessary delays and lead to driver frustrations and traffic disobeying or ignoring the traffic signal. The introduction of a traffic signal on a main route may also lead to delays that did not previously occur. The benefits of traffic signals must therefore be carefully considered.

4.2 Warrants for Traffic Signals

The installation of traffic signals should not be carried out unless there has been an in-depth investigation to determine if they are warranted in terms of their ability to improve traffic operations and safety. It is also essential that there be an on-going commitment to the maintenance of the signal installation.

The signalisation of an intersection should be provided where the existing method of control, e.g. a stop or yield control, cannot cope with the traffic flows and there are increasing delays and accidents as a result. Delays are manifested by long queues of traffic on the side roads waiting to cross or turn into the main road, and waiting to turn left from the main road into the side road. There may also be high volumes of pedestrians wanting to cross at an intersection. If there are excessive delays at an intersection this can result in a safety problem because drivers (and pedestrians) may become frustrated at the delay and then take risks. This may result in an increase in accidents at an intersection.

It should be realised that the installation of traffic signals may create new delays for traffic on the main road, because drivers previously did not have to stop, while reducing delays on a side road. The dis-benefit to the traffic on the main road and the benefits in reduced delays to traffic on the side road should be carefully considered.

A further factor to be considered is that where an intersection is not isolated and is located near to other traffic signals, there may be benefits in signaling the intersection and coordinating the traffic signal settings with the other intersections, in order to improve traffic flow and overall delays on an area-wide basis.

As stated in section 4.1 above, the installation of traffic signals is not always the best solution and the alternatives (e.g. geometric improvement, mini circles etc.) should first receive consideration.

Many authorities adopt a system of "Warrants" with which the need for traffic signals can be assessed, instead of carrying out a detailed engineering analysis. Experience has shown in many

countries that there is a level of traffic activity above which signals are needed. Above this level delays become unacceptable and an increase in traffic accidents can result.

The SADC Road Traffic Signs Manual (Department of Transport, South Africa, May 2012) uses the length of traffic queues as the criteria for establishing if traffic signals are warranted. Queues can be comprised of vehicles, pedestrians or cyclists stopped or waiting at a junction in a single lane. The length of a queue is deemed to be proportional to the total delay at the intersection and is an indication of the accident potential. As queues build up, delays increase. The following queue length warrants have been adopted in the SADC manual:

“The INSTALLATION of a traffic signal is deemed warranted at a junction, pedestrian or pedal cyclist crossing when ANY one of the following three queue length warrants are met:

- WARRANT 1: The average length of ANY individual queue equals or exceeds four (4) over any one hour of a normal day.
- WARRANT 2: The SUM of the average lengths of all queues equals or exceeds six (6) over any one hour of a normal day.
- WARRANT 3: The SUM of the average lengths of all queues equals or exceeds four (4) over each of any eight hours of a normal day (the hours do not have to be consecutive, but they may not overlap).”

The implementation of the above warrants requires extensive surveys of traffic queues in the field. Queues are measured every 15 to 60 seconds on each approach lane over the required period and are averaged.

A second method of determining average queue length is by means of traffic modelling. This is not as accurate as conducting actual on site surveys, but can be useful if field measurements are not

possible or where a new intersection is being designed. A variety of computer software is available which can determine average queue lengths e.g. the SIDRA software mentioned in section 4.4 above.

Other methods typically use a series of empirical graphs on which traffic flows on the main and minor approaches are plotted to determine a warrant e.g. "Traffic Signal Warrants" published by the Texas Transport Institute^(Institute, March 2008)

Reference should be made to the above sources should additional technical detail be required.

It is recommended that the warrants for traffic signal control should be determined by a suitably qualified and experienced Traffic Engineer.

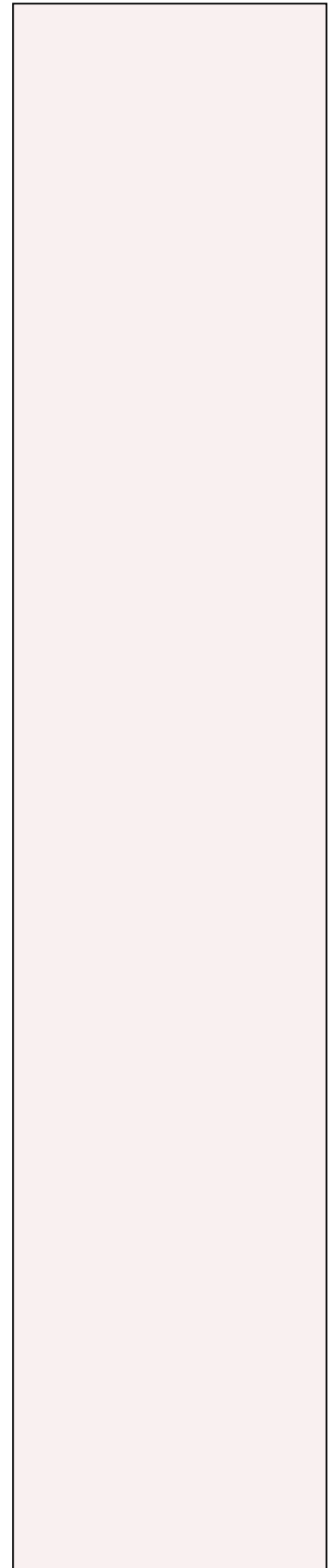

4.3 Vehicle Signal Indications

In Nigeria the following traffic light system is used:

- A steady green light signal, followed by
- A steady yellow light signal, followed by
- A steady red light signal, followed by
- A steady yellow and red light signal shown together.

The above sequence is shown in the following diagram.

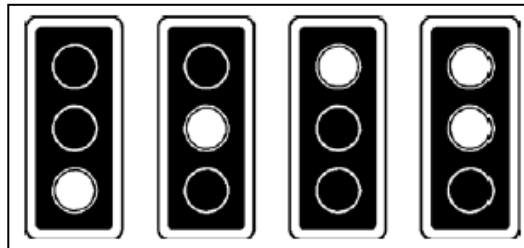

Figure 4.1: Nigerian Traffic Light System

4.3.1 Red Light Signals

A steady red disc indicates that a driver should stop behind the stop line and shall only proceed when a green light is displayed and it is safe to do so.

A steady red arrow indicates that a driver should stop behind the stop line if the driver intends to proceed in the direction indicated by the arrow, and shall only proceed when a green light is displayed and it is safe to do so. (See the Figure 4.2 below)

4.3.2 Yellow Light Signals

A steady yellow disc indicates that a driver should stop behind the stop line and shall only proceed when a green light is displayed and it is safe to do so. If the driver is so close to the stop line when the

yellow signal is displayed that he/she cannot stop safely, the driver may then proceed with caution through the yellow light.

A steady yellow arrow indicates that a driver should stop behind the stop line if the driver intends to proceed in the direction indicated by the arrow, and shall only proceed when a green light is displayed and it is safe to do so. If the driver is so close to the stop line when the yellow signal is displayed that he/she cannot stop safely, the driver may then proceed with caution through the yellow light. (See the Figure 4.2 below)

4.3.3 Green Light Signals

A steady green disc indicates to the driver that he/she may proceed straight or turn to the left or right, but shall yield to other vehicles or pedestrians.

A steady green arrow indicates to the driver that he/she may proceed in the direction of the arrow and that the movement is unopposed by other traffic. (See the Figure 4.2 below)

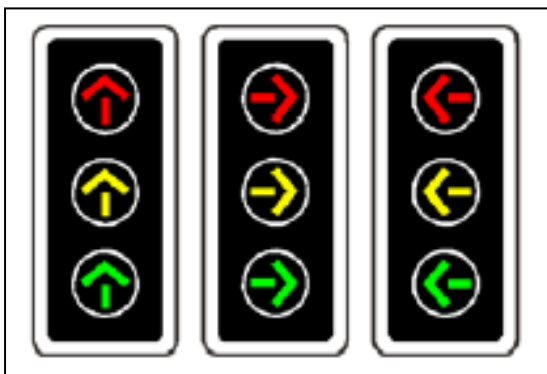

Figure 4.2: Example of Steady Arrow Signals

4.3.4 Yellow and Red Light Signals Shown Together

A steady yellow light shown together with a steady red light is shown immediately before a steady green light to indicate to drivers

that the green phase is about to commence. This may form part of the all red clearance time at the signal.

4.3.5 Flashing or other Modes of Operation

When a traffic signal develops a fault it may be switched to a flashing yellow disc light on all approaches. Drivers should then treat the intersection as a three or four way stop.

Alternatively the signals may be switched off completely. This can also be done when the intersection is controlled by a traffic officer on point duty.

4.3.6 Arrangement of Light Signals

Traffic light signals on a traffic signal face with red, yellow and green lights must be arranged in line vertically with the red on top, yellow immediately below the red and the green immediately below the yellow. If there is a second green arrow, it must be arranged in line vertically immediately below the first green arrow. A straight ahead arrow must be above a left or right arrow, and a left arrow must be above a right arrow.

The standard signal face and the arrangement with more than one arrow are shown in the following figures:

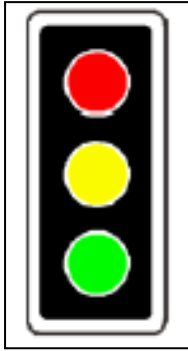

Figure 4.3: Standard Signal Face

The standard signal face in the above diagram may be used when traffic is permitted to move in any direction. The standard signal face may not be used on the same approach as the signal face with arrows shown in the following diagram, because of the conflicting meaning of the green arrows and the steady green disc.

The signal faces shown in the following diagram should be used to signal protected turning phases and only if there is no traffic opposing this phase.

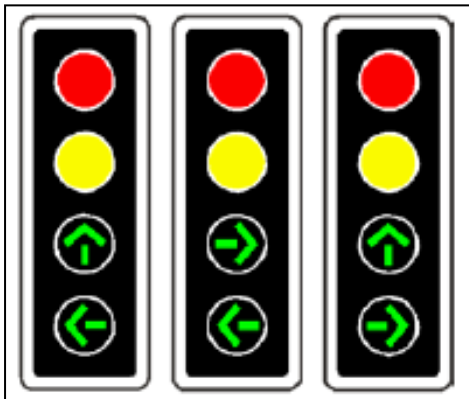
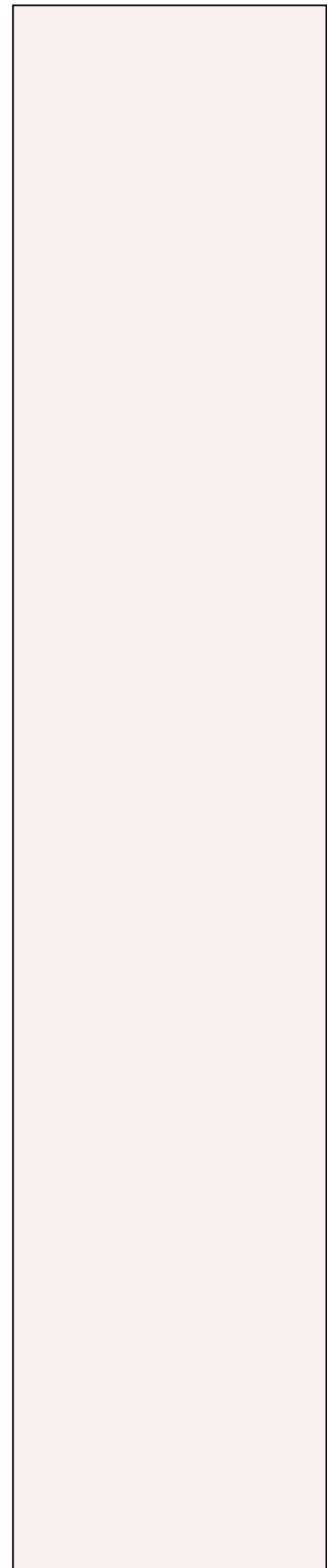

Figure 4.4: Signal Face with Arrows

The yellow and green light signals that contain two light signals shall be positioned in line vertically with the yellow above the green (see the Figure 4.5 below).



When two or more signal faces are mounted in a horizontal group, the lights of the same colour should be placed horizontally alongside each other (see the Figure 4.5 below), except as in the example in the above Figure 4.4 (signal face arrows).



Figure 4.5: Signal Groups

4.3.7 Pedestrian and Pedal Cyclist Signals

Pedestrian and pedal cycle signals are provided in conjunction with vehicle signals at signalized intersections or at signalized mid-block pedestrian or cyclist crossings.

Pedestrian or pedal cycle signals comprise:

A steady green man signal, followed by a flashing green man signal, followed by a steady red man light. The meaning of the signals is as follows:

- A steady green man signal: A pedestrian or cyclist may cross and motorists have to yield
- A flashing green man signal: A pedestrian or cyclist who has not started crossing may not cross until the steady green light is shown
- A steady red man light: A pedestrian or cyclist may not cross until the steady green man light is shown.

4.4 Location and Visibility of Traffic Signals

Traffic signal faces for use at junctions comprise of “Principle” signal faces that are required to meet minimum safety standards and legal requirements, and “Supplementary” signal faces that are required to improve visibility, safety standards and traffic operations.

4.4.1 Number and Location of Traffic Signal Faces

The following “Principle” traffic signal faces are required at a signalized junction, slipway or signalized crossing to control traffic on each approach:

- At least two “Principle” traffic signal faces on the near side of the junction positioned approximately on the extension of the stop line, one on the left and one on the right of the road. If the road is a dual carriageway with a constructed median island at least 1.2 metres wide, then the left hand traffic signal face should be positioned on the median island. The two traffic signal faces should not be more than 16 to 20 metres apart.
- If a separate left turn signal face is to be provided, at least two “Principle” traffic signal faces incorporating a left turn arrow must be provided, one on the near side and one on either the far side or near side of the junction.
- When a separate right turn signal face is required, at least one “Principle” signal face incorporating a right turn arrow should be provided on the near side of the junction.
- Even if the above minimum requirements are met, additional signal faces can be provided if required to improve visibility.

It should be noted that if a protected left turn phase is provided using the traffic signal face shown in Figure 4.4 and Figure 4.5, the left turn phase cannot be provided at the same time as the main signal phase, due to the conflicting meaning of the steady green arrow and the steady green disc.

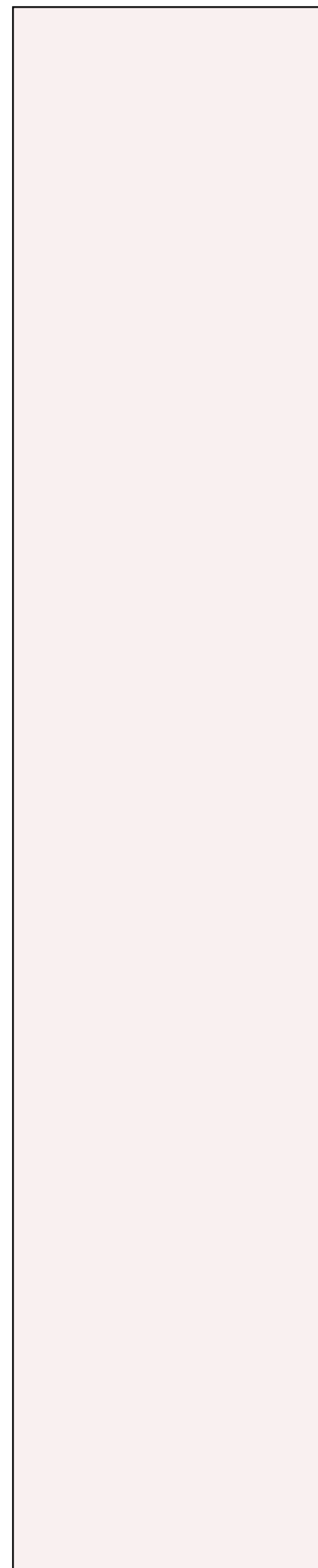

On high speed roads the speed limit on the approach to a traffic signal should not exceed 80 km/hr. If the speed limit is higher than 70 km/hr, high intensity traffic signals or overhead gantry traffic signals should be used. High visibility warning signs, a skid resistant road surface or traffic calming (rumble strips) should be used on the approach.

4.4.2 Visibility and Mounting of Traffic Signal Faces

Under normal conditions traffic signal faces should be clearly visible. Consideration should be given to the provision of high intensity traffic lights on high speed roads (80 km/hr) and other locations e.g. where the light may be affected by setting sun or where there is a cluttered background caused by other lights or signs.

The traffic signal can also be equipped with black backing boards or protective cones over the lenses to improve visibility. It is also recommended that the poles on which the traffic lights are erected should be painted yellow. Reflective strips can also be placed on the supporting poles.

Traffic signals should comply with minimum sight distances required as indicated in Table 4.1.

:

Table 4.1: Sight Distances for Traffic Signals

Operating Speed: km/hr	Urban Minimum (m)	Urban Preferable and Rural Minimum (m)	Minimum clear visibility distance of sign (m)
40	55	130	
50	80	160	60
60	110	190	80
70	140	215	100
80	170	240	120

Source: (Department of Transport, South Africa, May 2012)

The figures in Table 4.1 may need to be increased by 10 to 15 percent for downgrades depending on speed.

Traffic signals should normally be mounted on standard poles, extended poles, or on overhead cantilever supports or gantry. The erection of traffic signals on cables is not recommended.

Lateral clearances to traffic signals, including backing boards should be a standard of 500 millimetres. This can be increased to 1000 millimetres if there is a steep cross-fall of the road towards the traffic light that can cause tipping of vehicles.

The “Principle” traffic signal faces should be mounted on poles at the side of the road at a position not more than two metres from the continuation of the right or left edge of the roadway i.e. excluding the turning radius. The traffic signal faces should be not less than 2.3 metres and not more than three metres, measured to the centre on the lowest light above the adjacent road surface. There should also be a minimum clearance of 2.1 metres above the sidewalk adjacent to the pole. If there are sight distance problems

e.g. a vertical curve at the intersection, then a supplementary signal may be mounted on the post at a height exceeding 3 metres.

Overhead mounted traffic lights are required if it is not possible to comply with the requirement that the “Principle” traffic signals on either side of the road be no further apart than 20 metres. Overhead traffic lights may also be required if there is a high risk of accidents. The minimum vertical clearance of an overhead mounted traffic light is 5.2 metres and the lowest light should not be more than 6.2 metres above the road level.

The position of traffic lights is shown in the following diagrams:

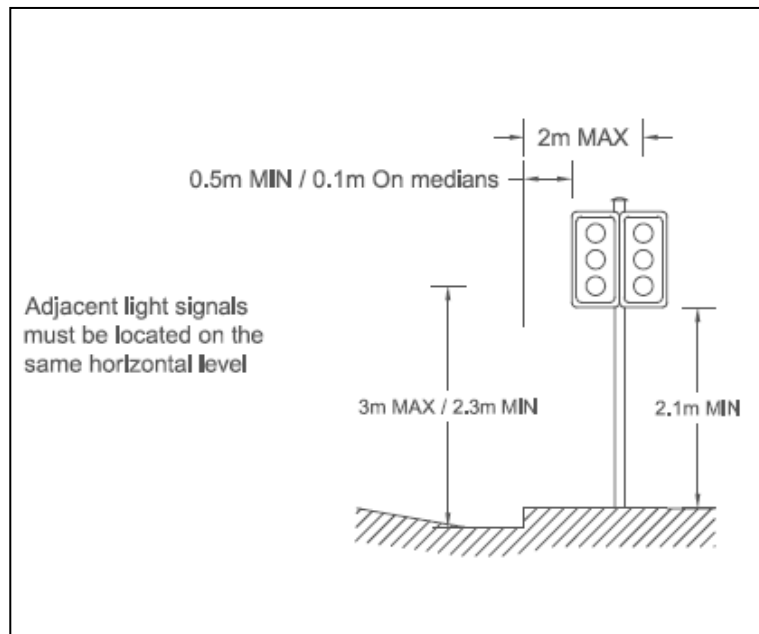

Figure 4.6: Standard Post Mounting

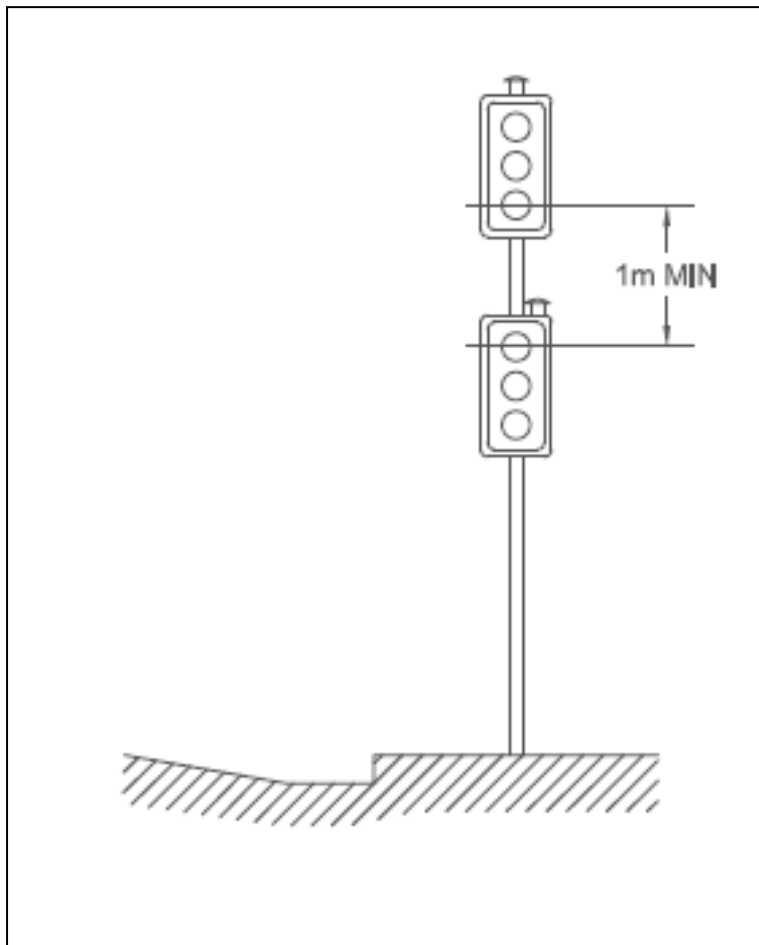
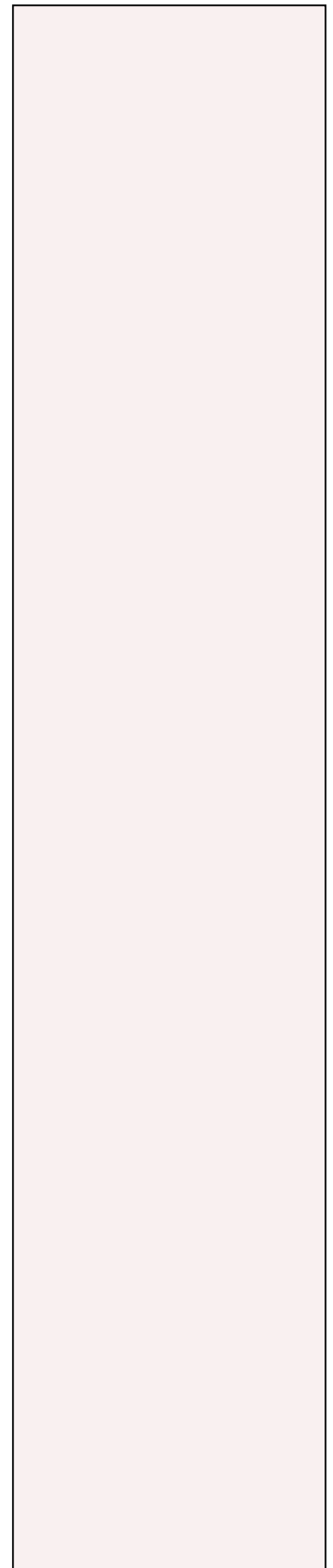

Figure 4.7: Extended Post Mounting



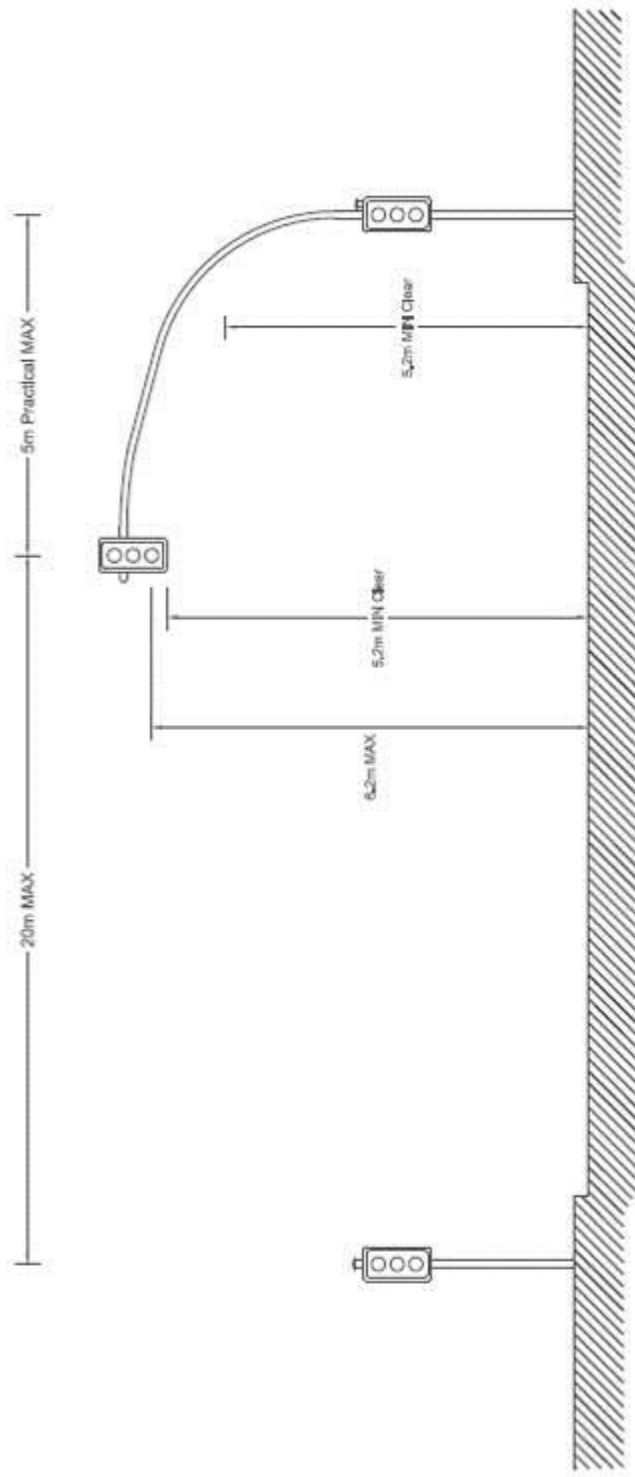

Figure 4.8: Overhead (Cantilever) Mounting

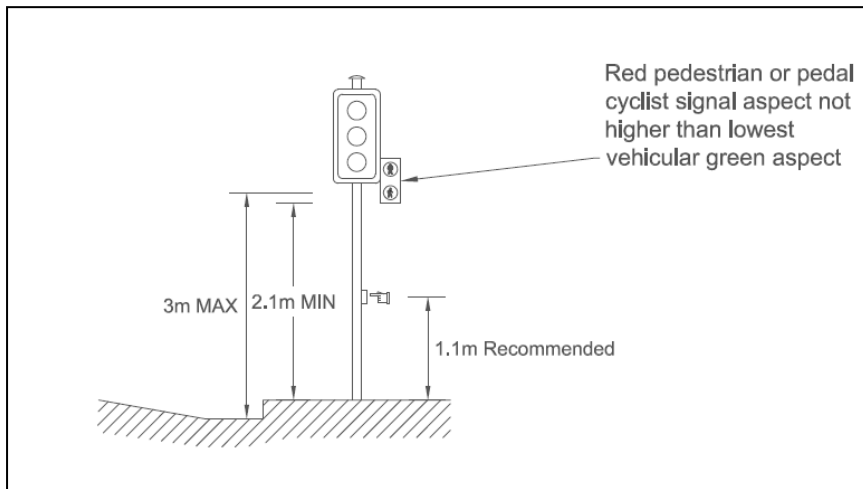
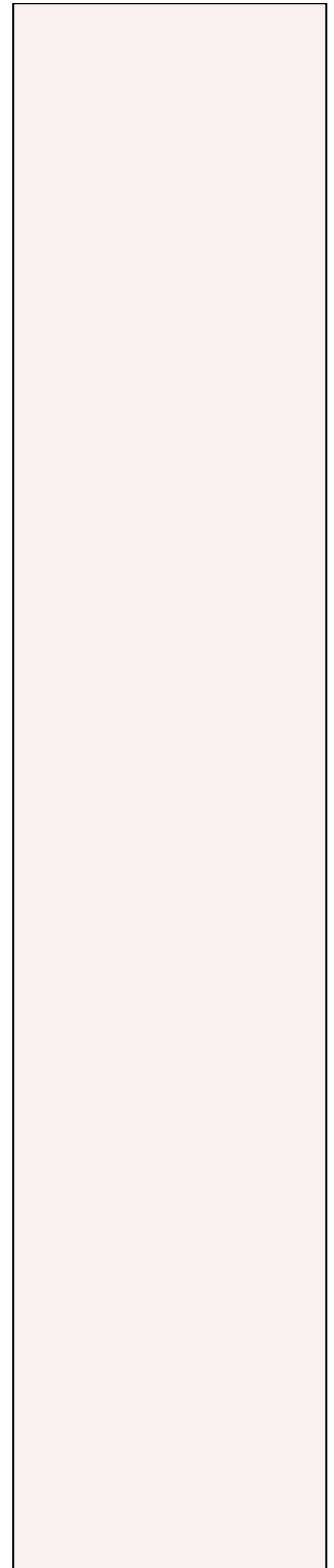

Figure 4.9: Mounting of a Pedestrian or Pedal Cycle Light Signal

For each traffic signal installation a traffic signal plan must be prepared, an example of which is shown in the following Figure 4.10:



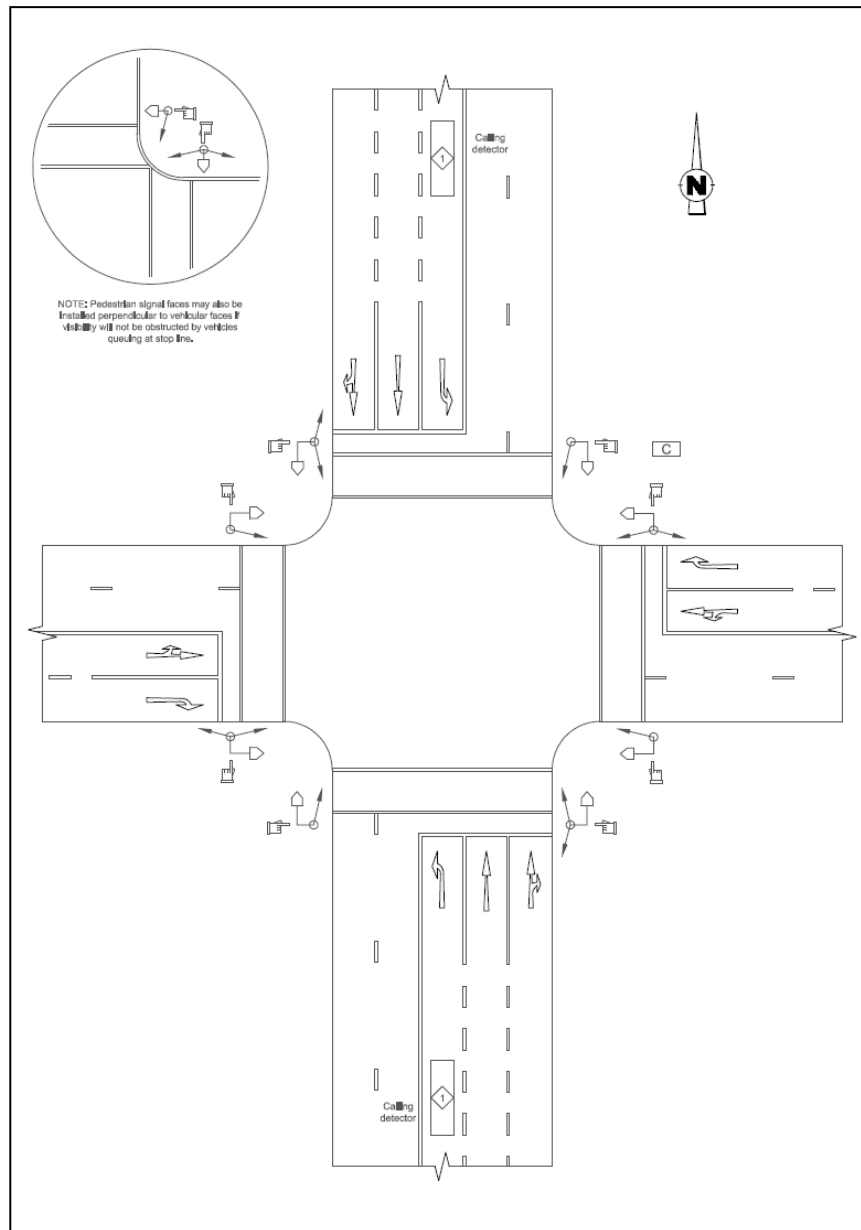

Figure 4.10: Example of Traffic Signal Layout Plan

4.5 Traffic Signal Timings and Phasing

The correct design for the timing and phasing of traffic signals is a prerequisite for the functioning of traffic signals. The incorrect signal settings will lead to the wastage of time and fuel by road users and can lead to driver frustration and drivers taking risks, leading to a greater risk of accidents.

Proper design of traffic signals requires careful planning, the collection of data, the analysis of the data, and the calculation of the most efficient signal timings to minimize delays at the intersection.

Several modes of operation of traffic signals are available depending on the circumstances, including fixed time signals, vehicle actuated control and traffic responsive control.

The design of traffic signals and traffic signal timings requires a high level of expertise and experience and should be carried out by a qualified Traffic Engineer.

The first step in any design is to collect comprehensive information on the current situation at an intersection. This can range from a scale drawing of the intersection showing road widths, lanes and any existing signs and street furniture, to a comprehensive traffic survey of existing traffic volumes per approach and lane. The traffic count should at least cover the morning and afternoon peak two hours as well as the heaviest off peak two hours.

The technical methodology required is beyond the scope of this Guideline. There are several references that should be consulted if further information is required, such as the following:

- Transport Research Board, 1997, Highway Capacity Manual, Special Report, National Research Council, Washington.
- Webster F.V. 1958, Traffic Signal Settings, Road Research Technical Paper No 39, Road Research Laboratory, U.K.
- Webster F.V. and Cobb B.M. 1966, Traffic Signals, Road Research Technical Paper No 56, Road Research Laboratory, U.K.
- Department of Transport, SADC Road Traffic Signs Manual – Digitised Version, May 2012.

In addition excellent software is available that can assist in traffic signal design. One of the best known is the following:

“SIDRA INTERSECTION” - According to the website SIDRA Intersection is “a powerful software package for timing, capacity, performance and level of service analysis of signalised intersections (junctions controlled by traffic lights) including signal coordination effects. It uses an advanced critical movement analysis method allowing for overlap movements and movements with two green periods per cycle, and determines signal timings using fixed-time / pre-timed and actuated signal analysis methods for any intersection geometry, allowing for simple as well as complex phasing arrangements involving overlap movements.” The software is available from: <http://www.sidrasolutions.com/>

5 Application of Traffic Signs, Road Markings and Signals

5.1 Longitudinal Placement

The longitudinal placement of signs is governed by the speed of the approaching vehicles and the greater the speed, the further in advance the sign needs to be positioned. This is necessary to provide the driver with time to react and respond to the message conveyed by the sign. The longitudinal position of signs also depends on the point of reference they refer to, for example, the beginning or end of road section to which a regulatory control applies, a road hazard e.g. a sharp curve or an intersection.

It is essential that drivers have an unobstructed view of the sign and the sight line should be free of obstructions e.g. foliage, other signs etc. The sight line also depends on speed and the higher the speed, the greater the distance needs to be.

Signs should be placed on the right hand side of the road; however some signs may be placed on the left hand side of the road as well for additional emphasis or if there is no convenient visible position on the right hand side.

5.1.1 Longitudinal Placement of Regulatory and Warning Signs

Generally, regulatory signs are placed at or as close as possible to the point to which they refer e.g. a STOP sign should be placed at the stop line. Other signs that are placed at the beginning of a section of road that has a restriction e.g. OVERTAKING PROHIBITED and apply over a specific length of road, following which they must be repeated.

Warning signs are generally place a specific distance in advance of a hazard. The distance depends on the speed of the vehicle to provide the driver with reaction time.

Table 5.1 indicates the typical recommendations for the distance a warning sign should be placed from a hazard and the typical sight (clear visibility) distance to a sign. A comparison has been made between the recommend distances contained in the UK Traffic Signs Manual, 2004 (UK-Department-of-Transport, 2004), the SADC Road Traffic Signs Manual (Department of Transport, South Africa, May 2012), and the figures contained in the SADC Road Traffic Signs Manual are recommended for use due to their simplicity.

Table 5.1: Sight Distances for Warning Signs

Operating Speed: km/hr	Distance of sign from hazard (m)	Distance of sign from hazard (m) Gravel Road	Minimum clear visibility distance of sign (m)
60	120	160	60
80	160	218	80
100	240	320	100
120	330	400	120

Source: (Department of Transport, South Africa, May 2012)

Table 5.1 above also indicates the recommended typical sight (clear visibility) distance for both regulatory and warning signs.

If it is impractical to place the sign within 10 (distance is not measured in percentages) of the recommended distance, then a position further away from the hazard should be selected.

5.1.2 Longitudinal Placement of Information Signs

Information signs are usually placed in advance of a junction or another facility such as a rest area. Information signs placed at a junction should be placed so that traffic passes in front of the sign,

particularly when the junction is controlled by a stop, yield or traffic signal. This allows the maximum time for the driver to read the sign.

On class “D” Secondary Roads with an operating speed of up to 100 km/hr. the minimum spacing of information signs should be 80 metres and a longitudinal spacing of 150 to 300 metres is recommended. On an expressway, freeway or arterial road, Class “A, B and C”, the recommended minimum spacing should be 200 metres.

On minor local roads, Class “E”, in dense urban areas, space constraints usually dictate the placement of information signs and care must be taken not to obscure other regulatory or warning signs.

When placing signs, care must be taken that the sign is not obscured by vegetation or street furniture etc.

The following figure indicates the recommended information sign sequence at a junction between Class “A” or “F” roads.

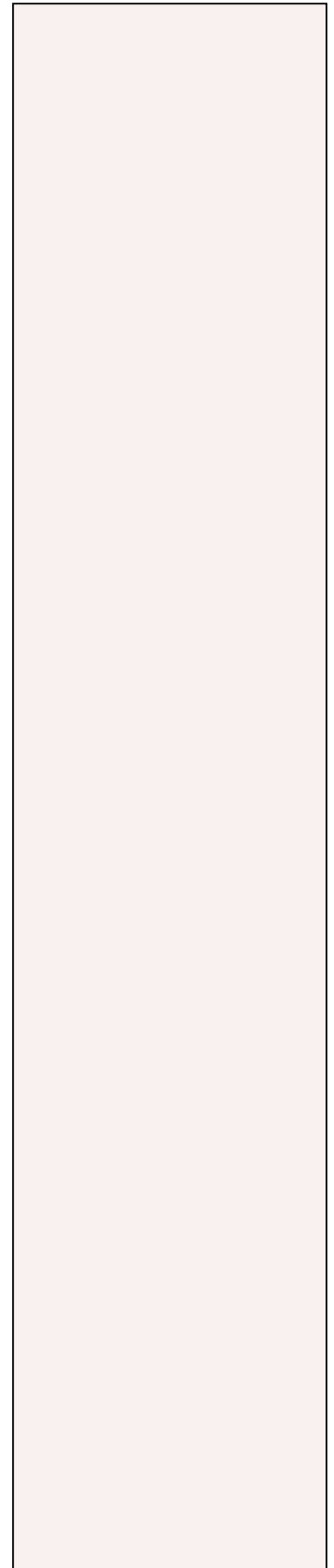

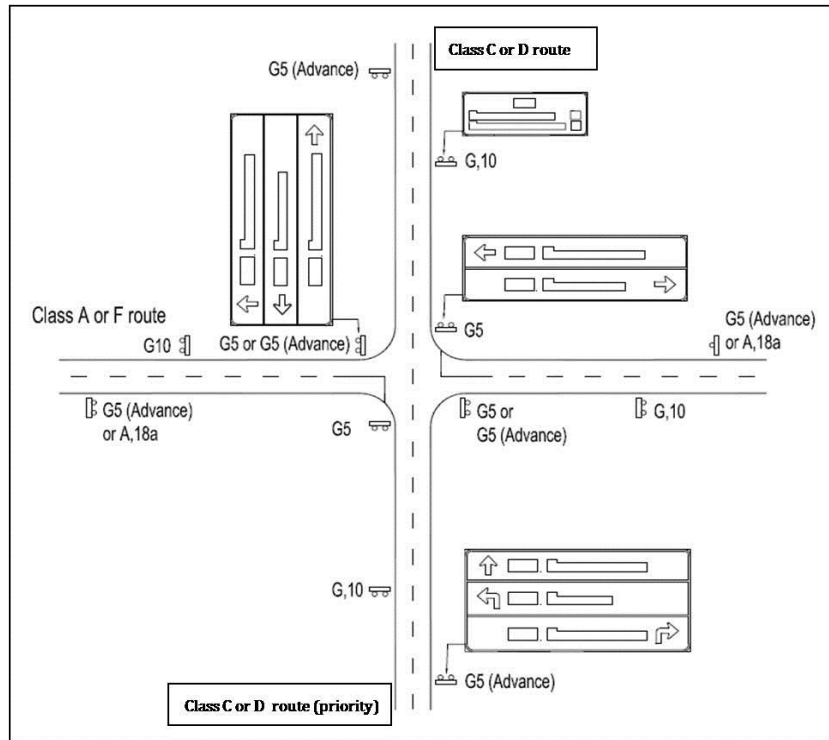

Figure 5.1: Junction Information Sign Sequence: Class C or D Road

Notes:

- 1) The above diagram represents the recommended sequence of information signage. The confirmation sign G, 10 is optional.
- 2) The advance direction sign G,5 (Advance) may be replaced by a warning sign A,18a or another appropriate warning sign on a non-priority Class C or D approach.
- 3) When a warning sign is used in advance, the G, 5 sign may be replaced by a composite G, 5 (Advance) sign.

Table 5.2 indicates the recommended distances that the advance direction signs should be placed from a road junction.

Table 5.2: Distance of Advance Direction Signs from a Road Junction

Operating Speed on the Approach km/hr	Operating Speed at Road Junction km/hr			
	20	40	60	80m
60	120m	90m	65m	65m
80	155 – 180m	140 – 165m	80m	80m
100	245 – 300m	220 – 275m	155m	130m
120	320 – 390m	310 – 360m	275 – 300m	145m

Source: (Department of Transport, South Africa, May 2012)

Note:

- 1) The longer distances should be used for gravel roads to allow for more gradual deceleration.

Figure 5.2 indicates the recommend sequence and placement of signage at a diamond access interchange where the exit ramps terminate at an at-grade junction.

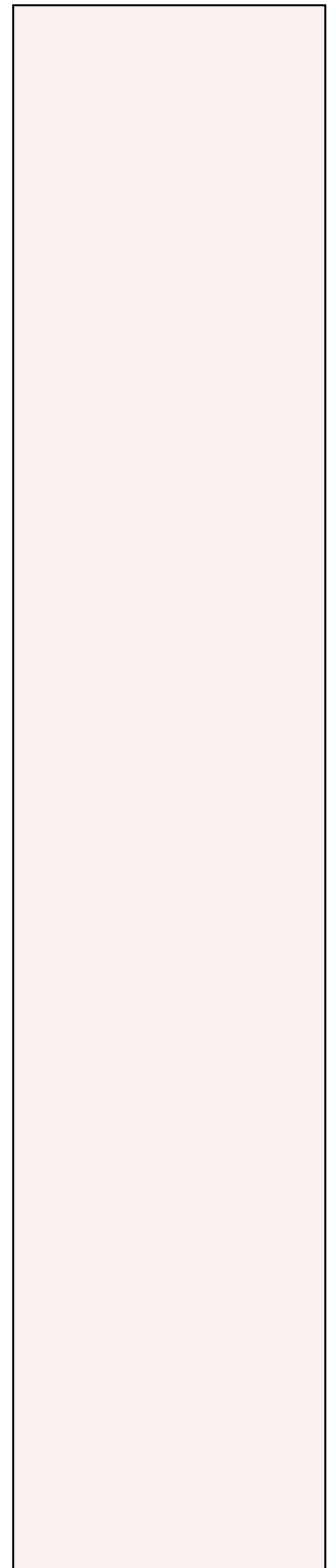

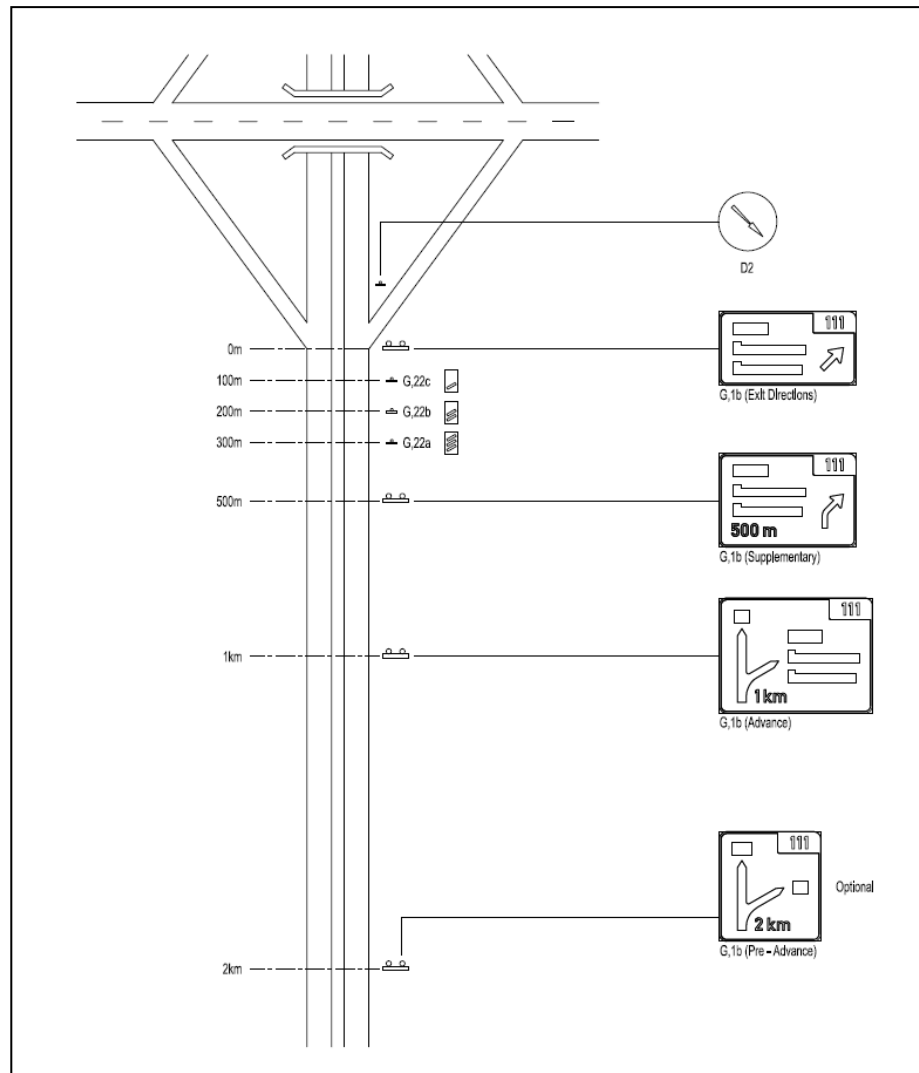

Figure 5.2: Ground Mounted Exit Direction Signs: Class A or B Road Access Interchange

Source: (Department of Transport, South Africa, May 2012)

Notes:

- 1) The G, 1b (Pre-Advance) sign is used at an interchange between two freeway systems (Optional for an Access Interchange).
- 2) The G, 1b (Supplementary) sign is used in heavy traffic conditions for additional emphasis.

Figure 5.3 shows the recommended signage on an off-ramp.

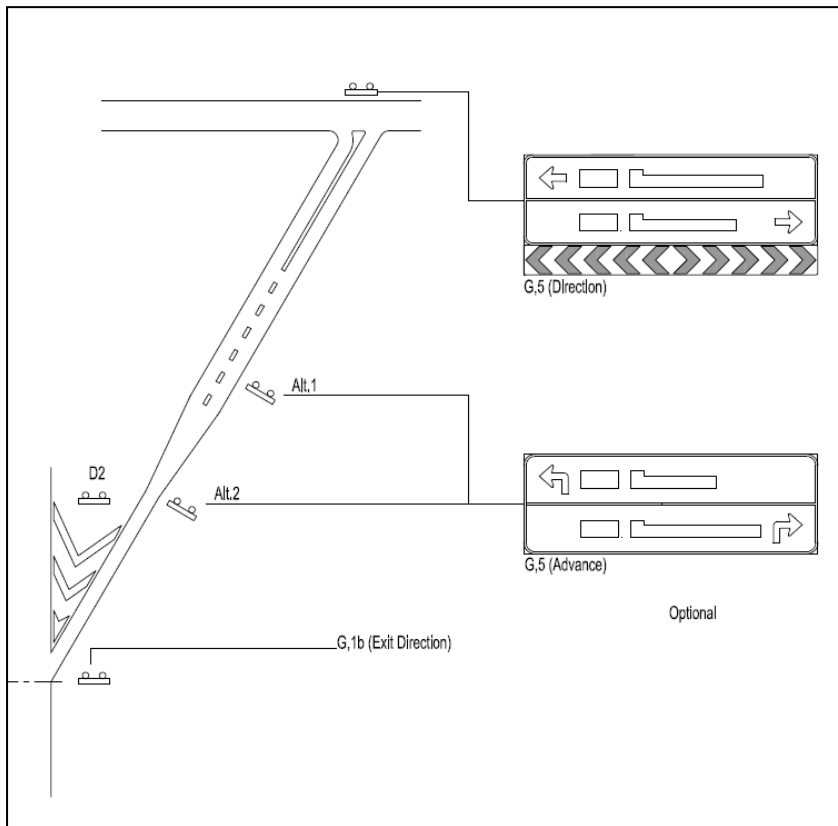

Figure 5.3: Off-Ramp Direction Signing

Source: (Department of Transport, South Africa, May 2012)

Notes:

- 1) The signs illustrated above may follow ground mounted or overhead signs on an expressway.
- 2) For sign G, 5 (advance), use position ALT2 if the off-ramp widens to two or more lanes.
- 3) For very high volumes or where two or more lanes are provided, the use of overhead signs should be considered.

Figure 5.4 indicates the recommended information sign sequence for ground mounted signs at a diamond interchange.

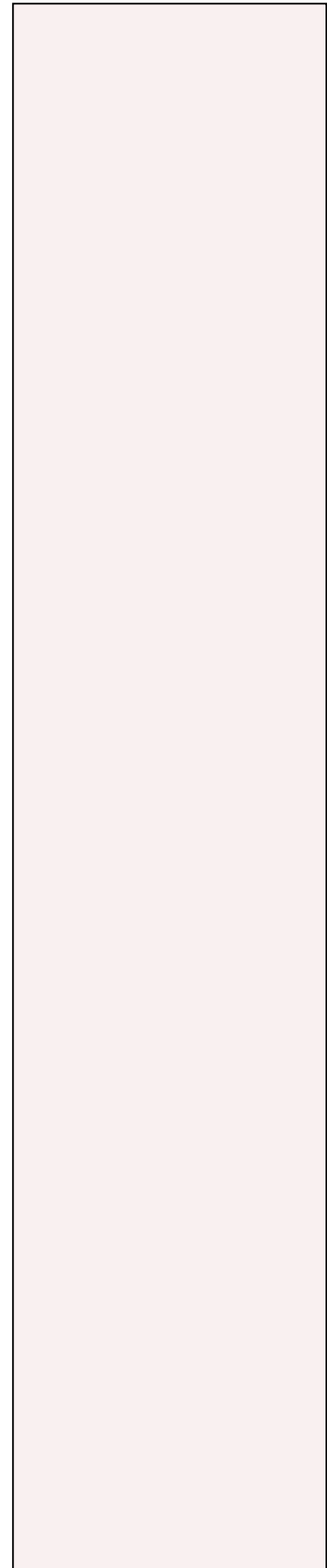

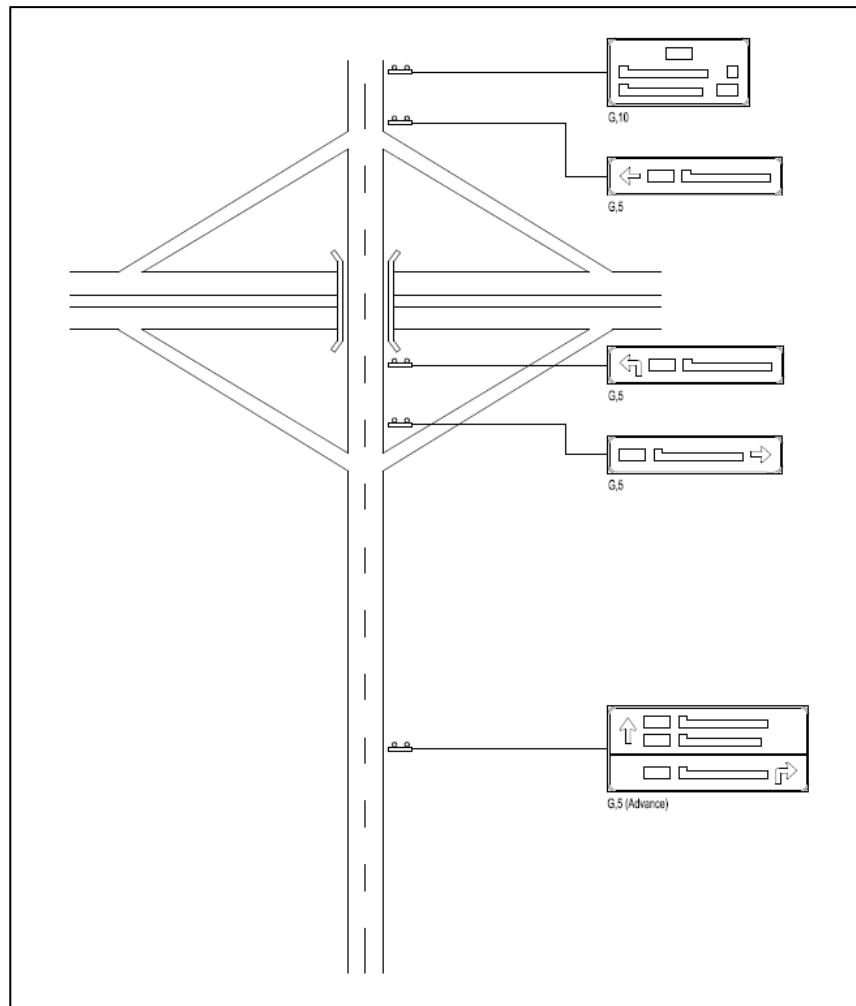

Figure 5.4: Ground Mounted Cross Direction Sign Sequence – Diamond Interchange

Source: (Department of Transport, South Africa, May 2012)

Figure 5.5 indicates the direction sign sequence for overhead signs at an access interchange. Overhead signs may be justified in certain situations such as on multi-lane expressways, arterial roads with at-grade junctions or in busy central business areas. Overhead signs may be required, inter alia, in the following circumstances:

- On heavily trafficked, multi-lane roads where ground mounted signs may be obscured e.g. three lanes or more or expressways with more than 50 000 vehicles per day
- At busy junctions where all the drivers concentration is likely to be ahead and not to the side of the road

- When it is uneconomical to mount signs on the side of the road
- On systems interchanges between freeways
- Where there is a high percentage of heavy vehicles
- On off ramps with more than three lanes.

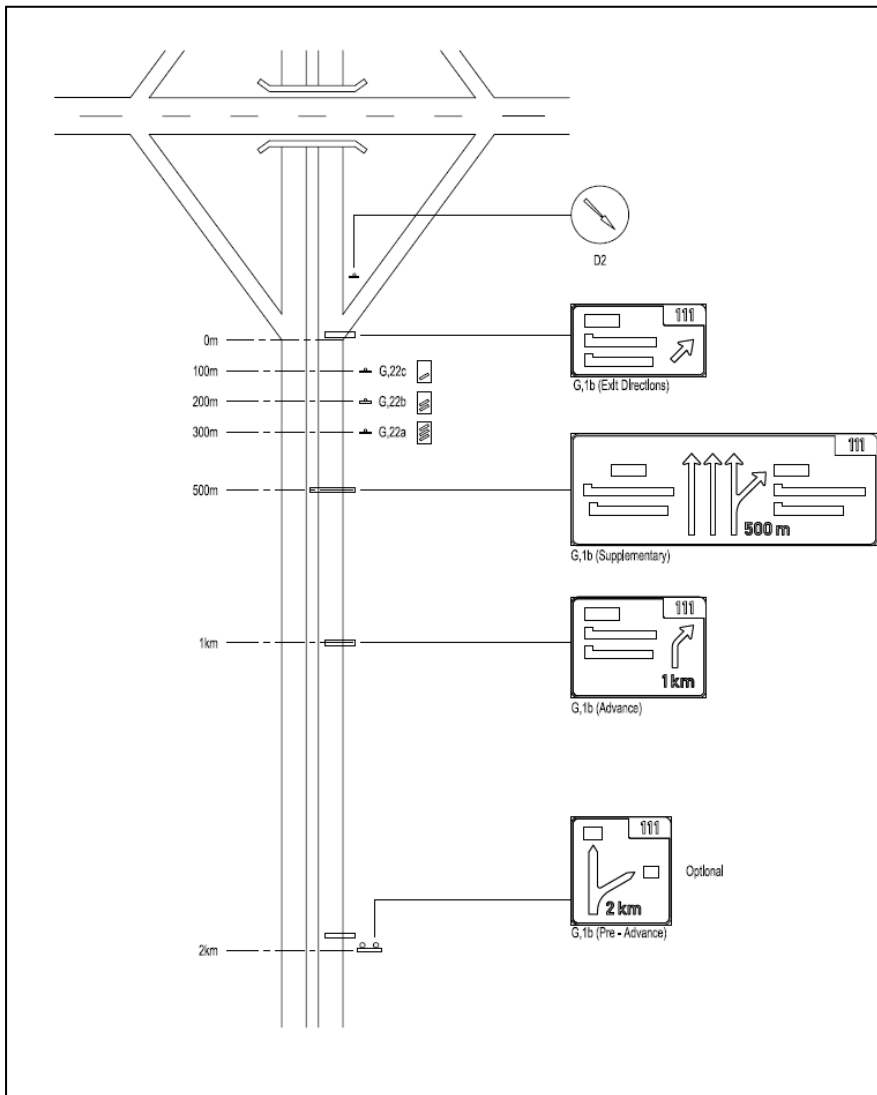
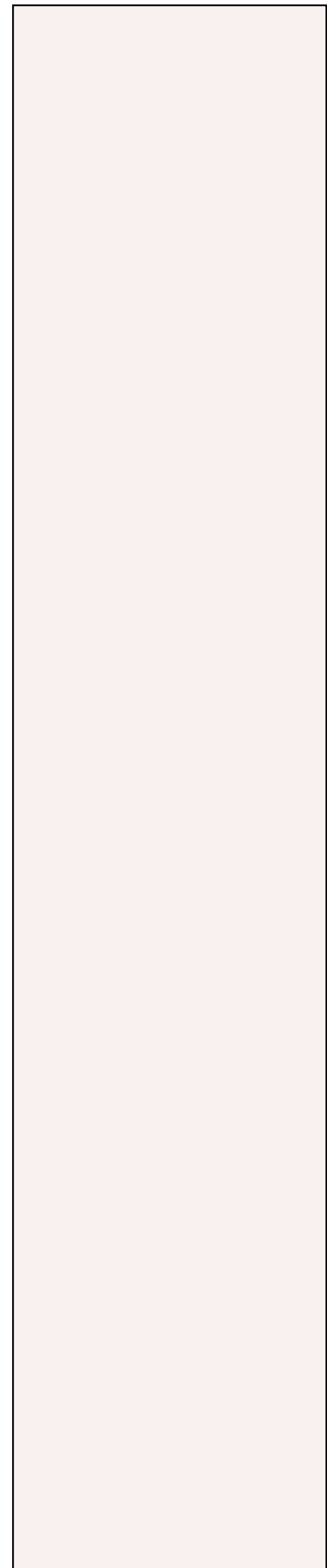

Figure 5.5: Overhead Exit Direction Sign Sequence – Access Interchange

Source: (Department of Transport, South Africa, May 2012)

Figure 5.6 indicates the recommended information sign sequence for overhead information signs at a systems interchange. There are many variations of sign configuration depending on the interchange



geometry. Reference literature should be consulted to view other possible layouts.

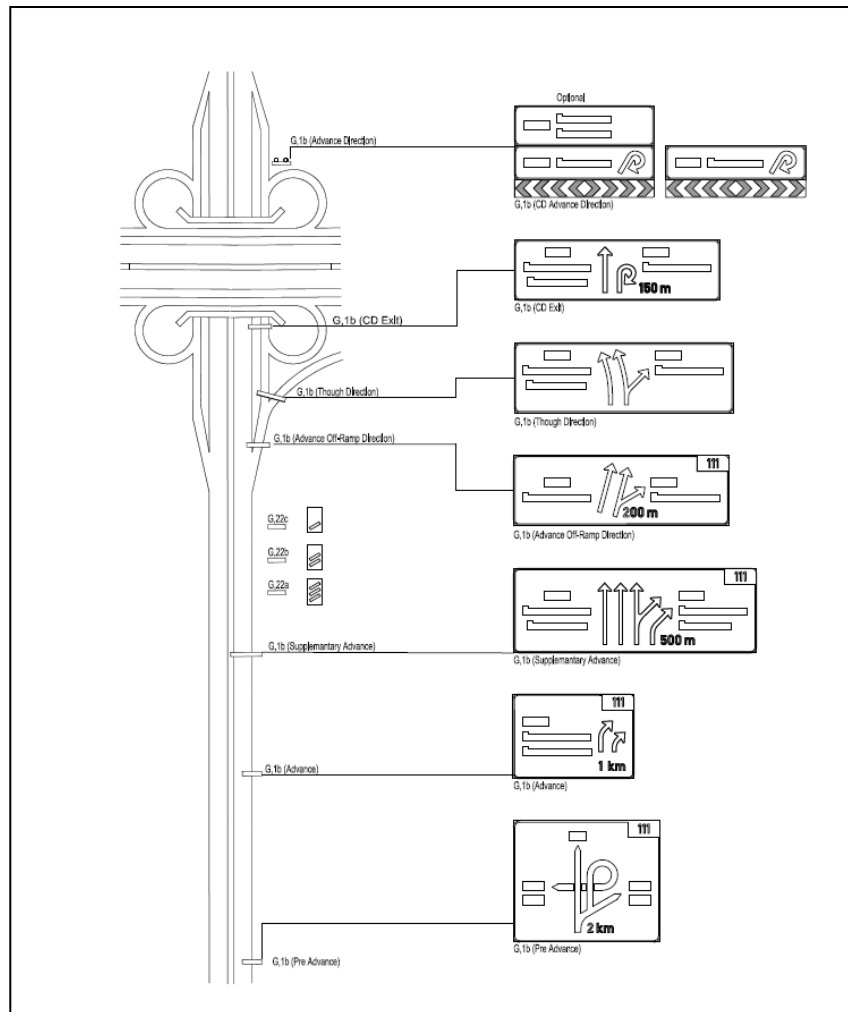

Figure 5.6: Overhead Direction Sign Sequence: Systems Interchange

Source: (Department of Transport, South Africa, May 2012)

Figure 5.7 indicates the recommended information sign sequence for ground mounted information signs at a parclo interchange.

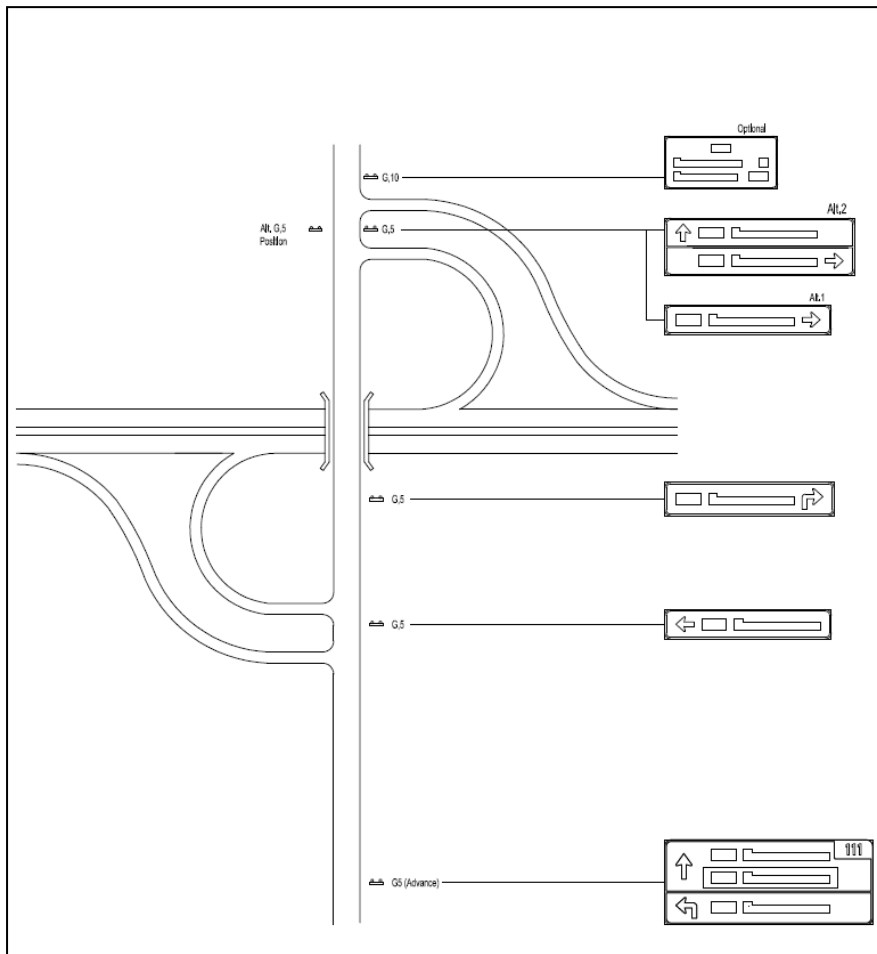

Figure 5.7: Ground Mounted Cross Road Direction Sign Sequence – Parclo Interchange

Source: (Department of Transport, South Africa, May 2012)

5.2 Lateral and Vertical Placement

5.2.1 Lateral Placement

The following diagrams indicate the recommended lateral placement of signs from the edge of the road way or shoulder. Care should be taken in positioning of signs so that the sign is not obscured by cut slopes.

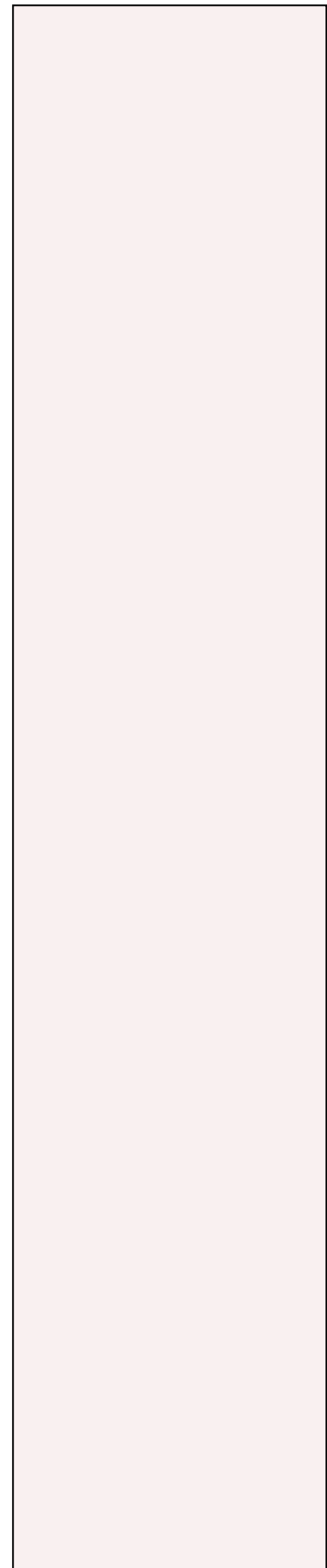

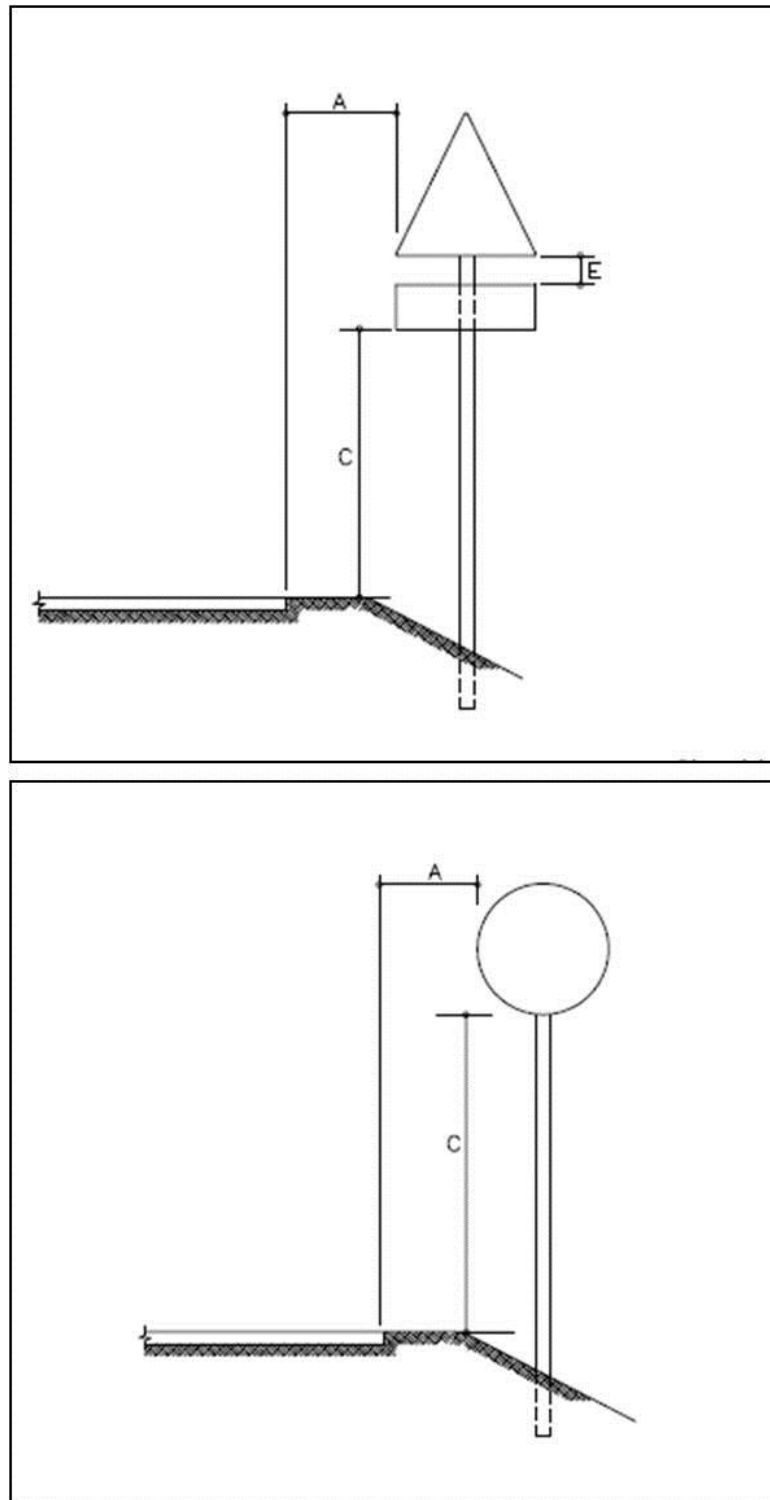

Figure 5.8: Placement of Regulatory and Warning Signs (Shoulder)

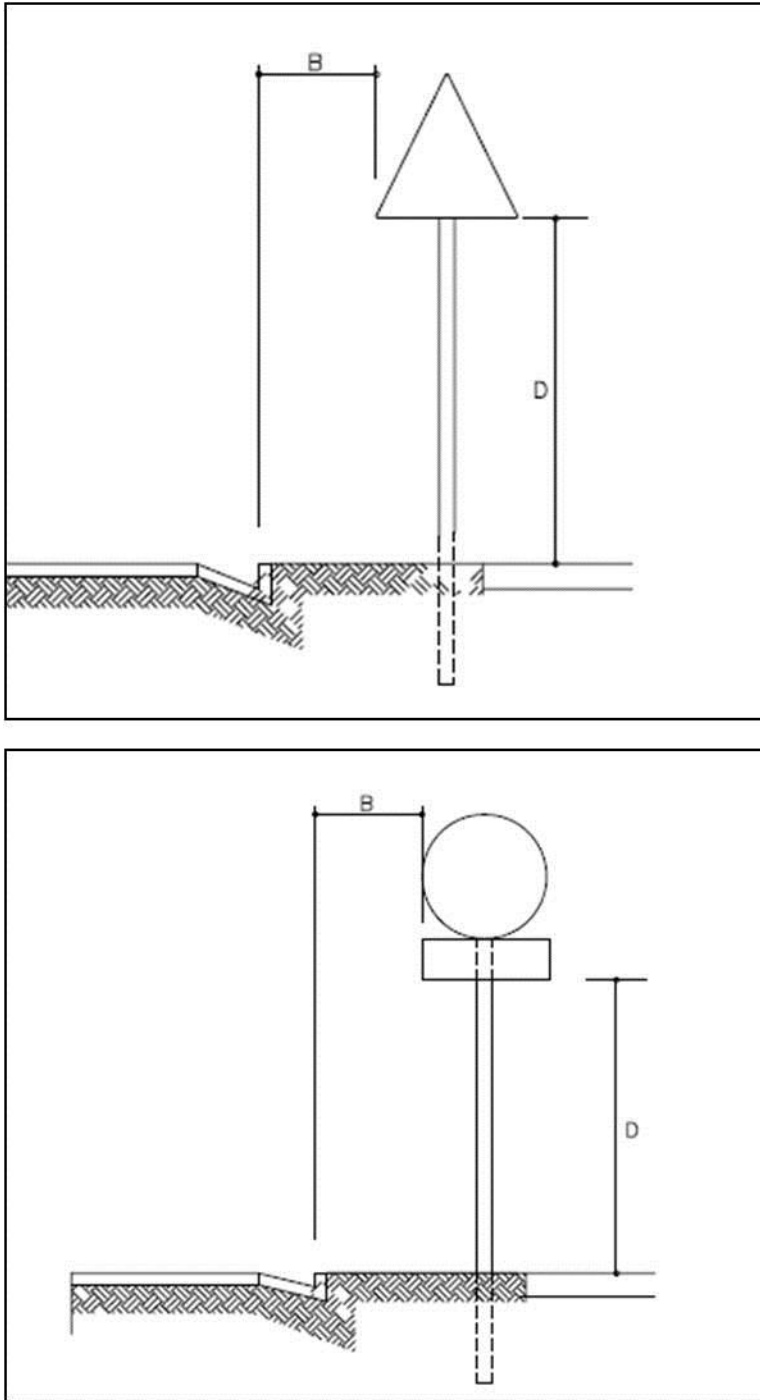

Figure 5.9: Placement of Regulatory and Warning Signs (Kerb and Sidewalk)

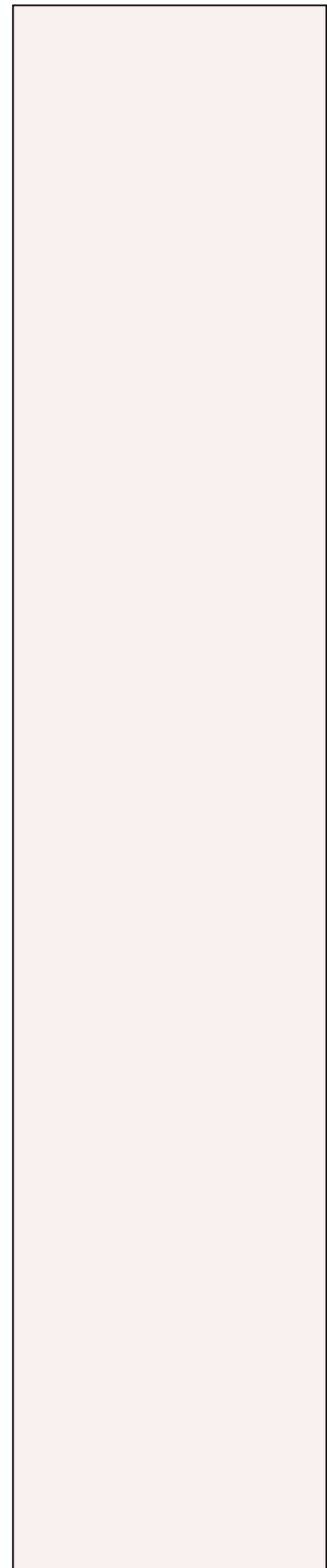

Table 5.3: Permanent Sign Placement Dimensions (Regulatory and Warning Signs)

Permanent Sign Placement Dimensions			
Dimension	Minimum (mm)	Preferred (mm)	Maximum (mm)
A	1200	1500	2000
B	500	750	-
C	600	2100	2500
D	2100	2500	3000
E	0	0	200

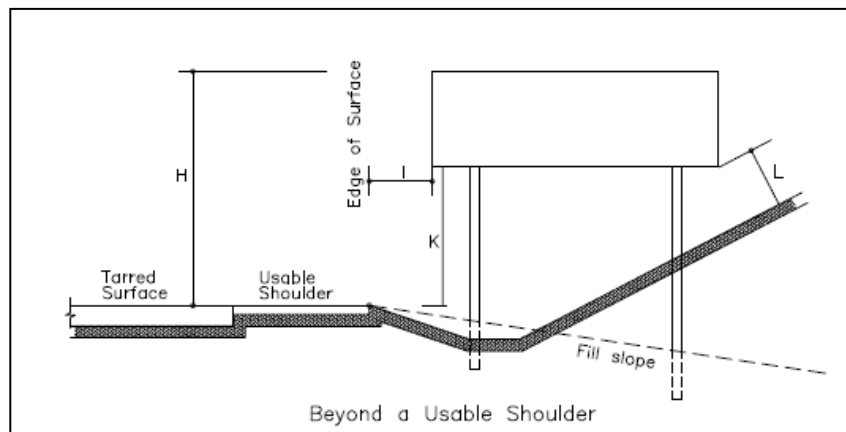

Figure 5.10: Placement of Multiple Support Information Signs (Beyond Usable Shoulder)

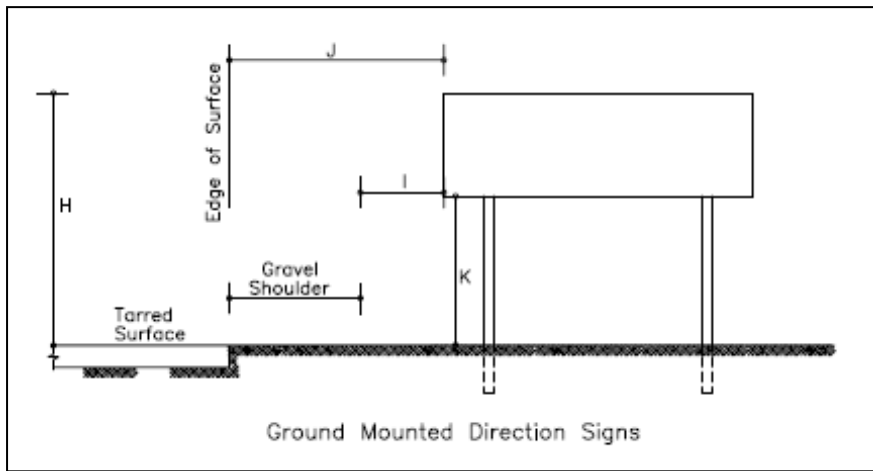

Figure 5.11: Placement of Multiple Support Information Signs

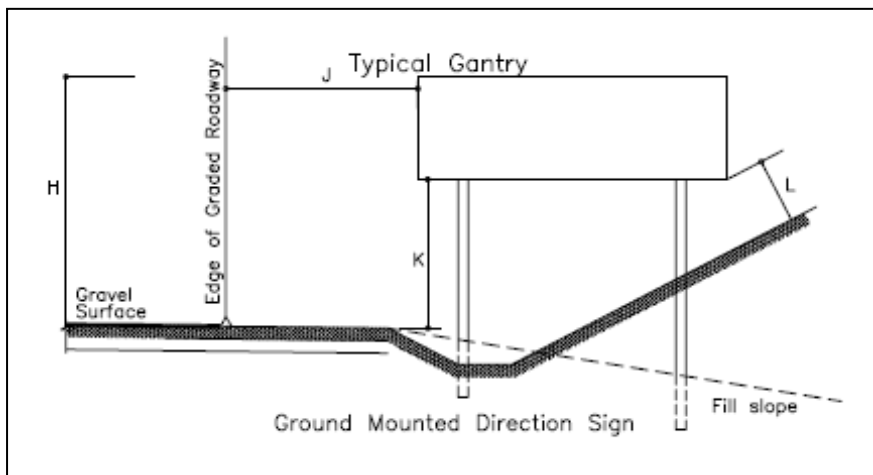

Figure 5.12: Placement of Multiple Support Information Signs

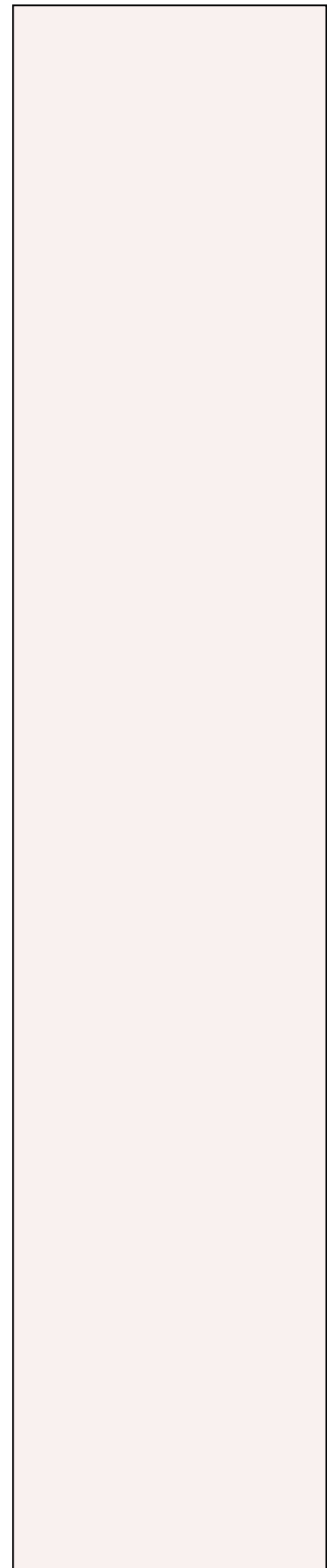

Table 5.4: Permanent Sign Placement Dimensions (Ground Mounted Information Signs)

Permanent Sign Placement Dimensions			
Dimension	Minimum (mm)	Preferred (mm)	Maximum (mm)
H	-	-	6000
I	1500	2500	-
J	2500	4000	-
K	1600	2000	2400
L	1200	-	-

5.2.2 Vertical Placement

Details of recommended vertical mounting heights for road signs are shown in the following diagrams (Department of Transport, South Africa, May 2012)

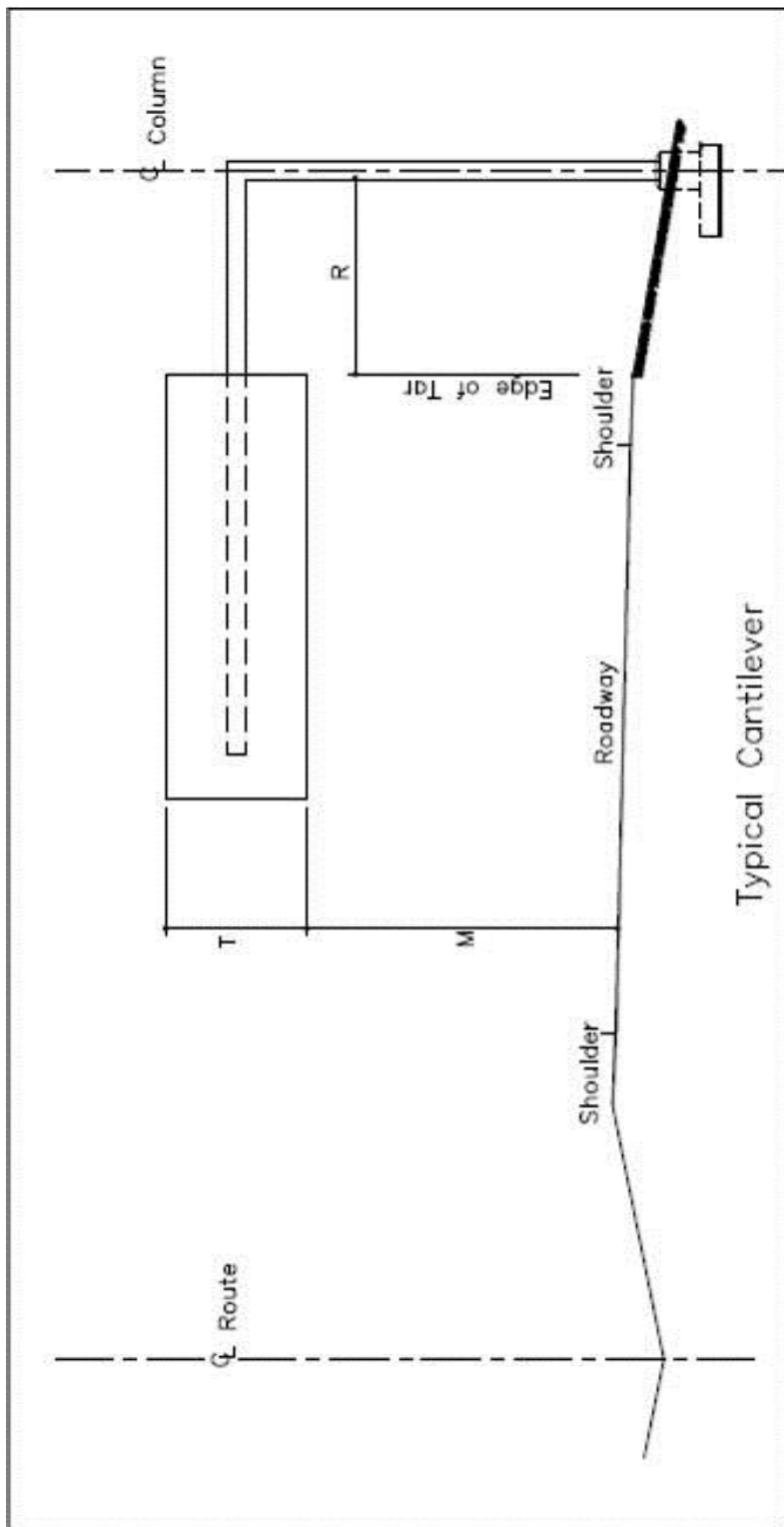
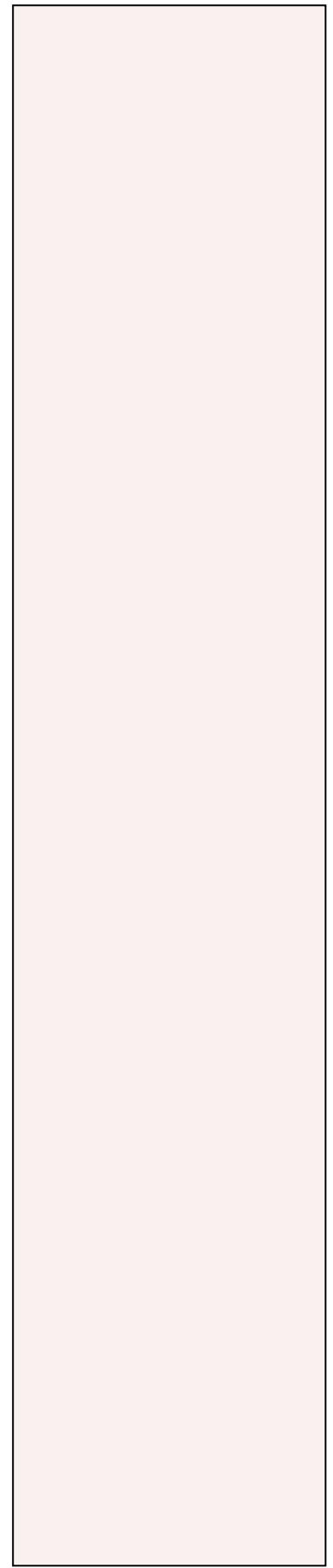

Figure 5.13: Placement of Overhead Cantilever Signs



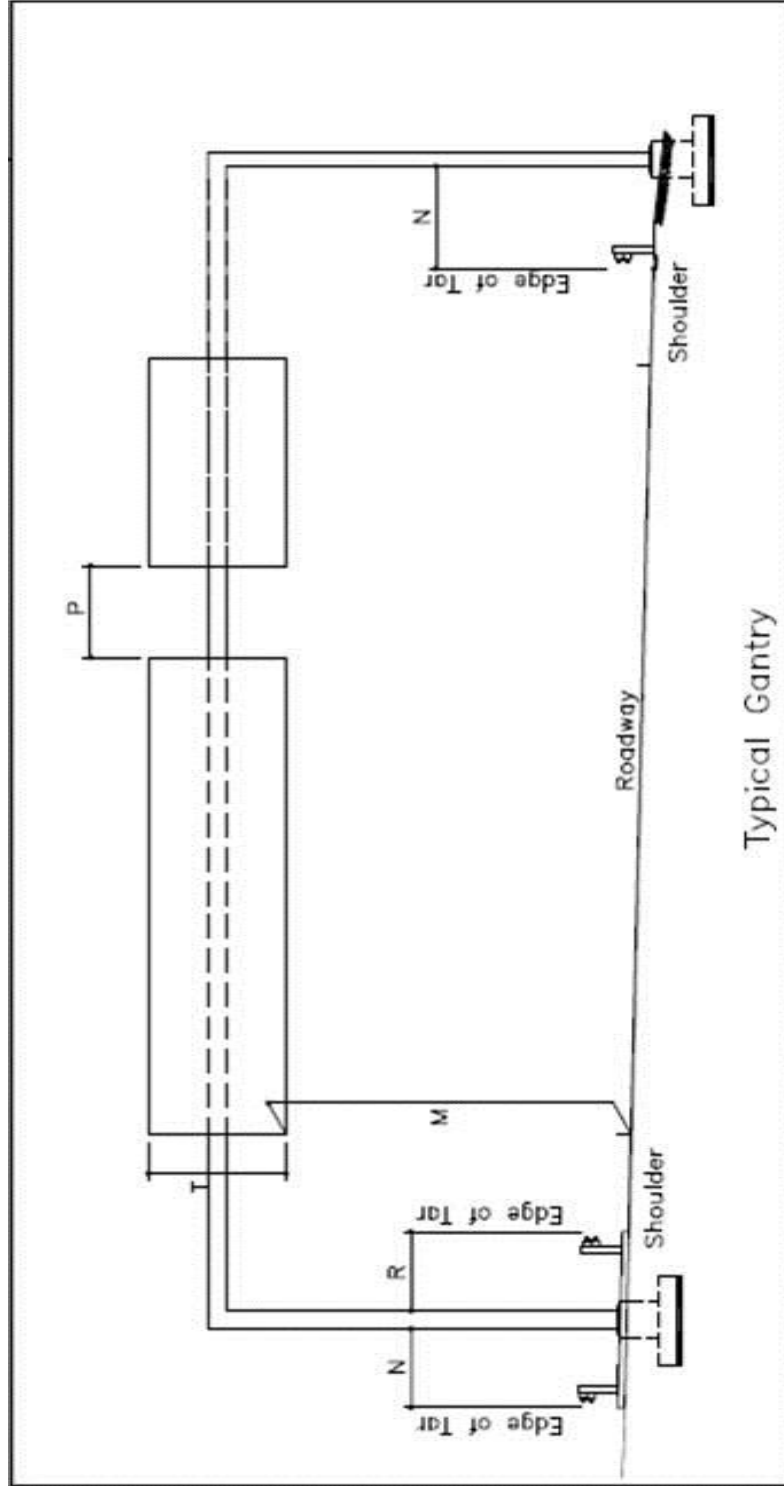
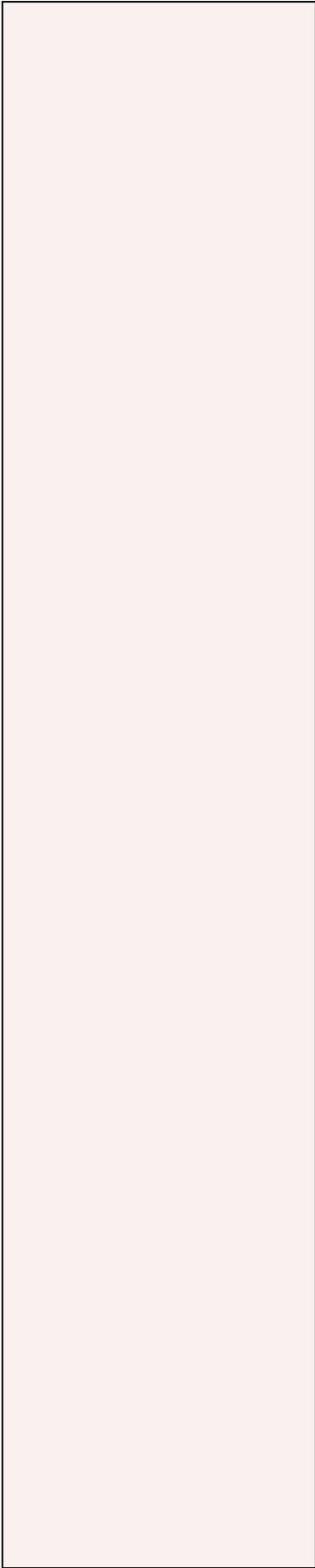

Figure 5.14: Placement of Overhead Gantry Signs

Table 5.5: Permanent Sign Placement Dimensions (Overhead Mounted Information Signs)

Permanent Sign Placement Dimensions			
Dimension	Minimum (mm)	Preferred (mm)	Maximum (mm)
M	5200	5700	6200
N	1500	2000	-
P	50	1000	-
R	4000	4500	-
T	1800	-	4200

5.3 Sizes and Design of Regulatory and Warning Signs

The size of signs is important in that the information must be read and assimilated by drivers from a moving vehicle. The size of the sign must therefore be appropriate to the speed of the vehicle. The following tables indicate the recommended sign sizes based on vehicle speed for regulatory and warning signs as recommended in the SADC Road Traffic Signs Manual (Department of Transport, South Africa, May 2012).

Table 5.6: Sizes of Regulatory Signs

Operating Speed: km/hr	100 or more	70 to 90	0 – 60	Stopping / Parking	Overhead Signs
Circular Sign Diameter (mm)	1200	900	600	450	1600

Operating Speed: km/hr	100 or more	70 to 90	0 – 60	Stopping / Parking	Overhead Signs
Rectangular Sign (mm) H x W	1200 x 900	900 x 675	600 x 450	450 x 340	1600 x 1200

Source: (Department of Transport, South Africa, May 2012)

Table 5.7: Sizes of Warning Signs

Operating Speed: km/hr	120	100	80	60
Height of triangular warning signs (mm)	1500	1500	1200	900

Source: (Department of Transport, South Africa, May 2012)

Letters and numerals appearing on regulatory and warning signs should have lettering on the DIN 1451 style. The width of the red border varies according to the size of the sign as shown in Table 5.8 with some examples:

Table 5.8: Width of Sign Borders (mm)

Sign Size (mm)	STOP B, 2a	NO ENTRY C, 1b	PEDESTRIAN CROSSING A, 12	ROUNDBABOUT A, 22
450	20	40	-	-
600	25	50	50	50
900	40	75	75	75
1200	50	100	100	100

In order to achieve uniformity of sign design and layout, it is recommended that suitable software be used to design the sign layout (Refer to the following section - Design of Information Signs).

5.4 Design of Information Signs

The design of information signs is dependent on the standard letter sizes, letter spacing used and the information content to be included on the sign. Standards have been adopted by both the United Kingdom Department of Transport Traffic Signs Manual (for traffic signs in the UK) (UK-Department-of-Transport, 2004) and the Southern African Development Community Road Traffic Signs Manual (SADC RTSM) (Department of Transport, South Africa, May 2012) (for traffic signs in South Africa and surrounding countries).

Both the above references base the design of information signs on a standard alphanumeric alphabet with variations for different types of sign.

The UK standard has two versions: Transport Medium for white characters on a green, blue, brown, red or black background, and Transport Heavy for black characters on a white or yellow background. To ensure the correct letter spacing, the letters are placed on imaginary “tiles” with a fixed height and a variable width depending on the character. Measurements are then taken from the edges of the tiles and not the characters.

The size of an alphabet is specified in terms of its x-height. This is the height of the lower case letter “x”, and is the same for both the Transport Medium and Heavy alphabets. The unit of measurement when designing a sign is the stroke width (sw) (which is one quarter of the x-height) and is not necessarily equivalent to the width of any given character. The dimensions for signs are then given in stroke widths unless otherwise stated.

Section 2 of Chapter 7 of the UK Traffic Signs Manual provides technical guidelines on the design rules for all rectangular signs and should be used as a reference when designing signs based on the UK standards.

Figure 3-7 of Chapter 7 of the UK Traffic Signs Manual shows a typical highway network comprising primary and non-primary routes. The signing of the network using the colour coding rules is illustrated by the five advance direction signs. The figure is reproduced below (Figure 5.15).

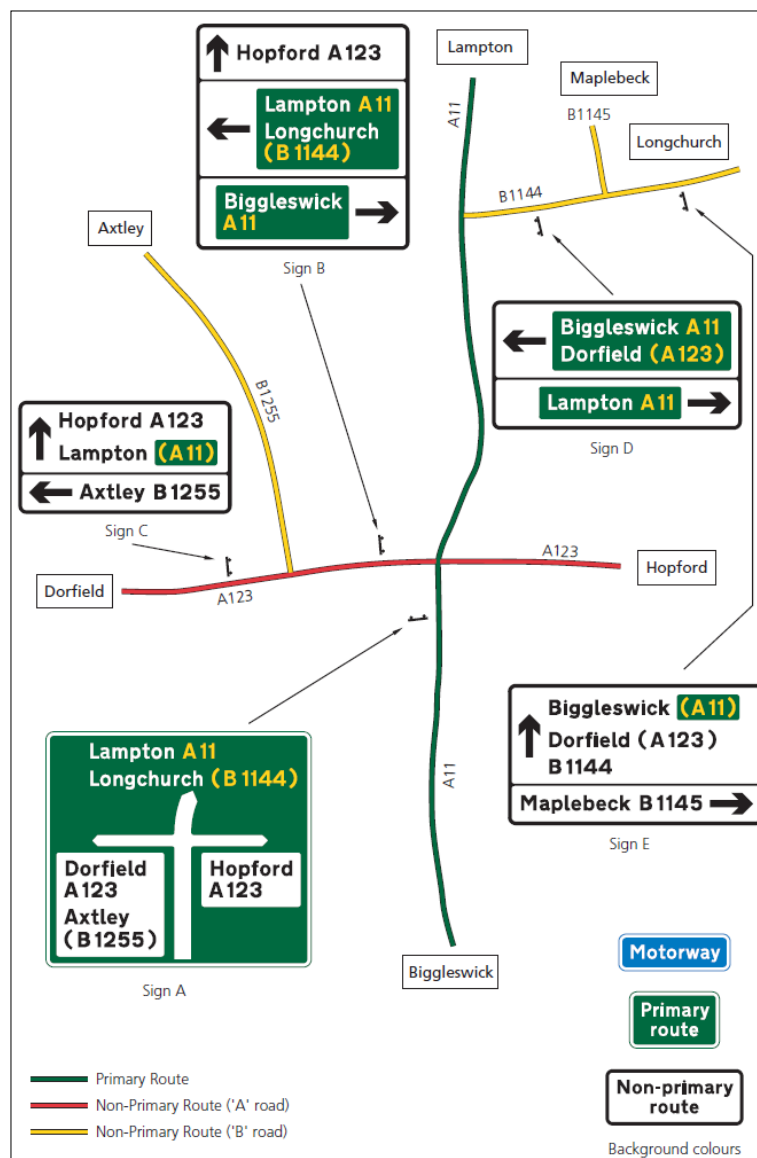

Figure 5.15: Typical UK Highway Network Signage

Source: (Figure 3-7 of UK Traffic Signs Manual) (UK-Department-of-Transport, 2004)

The design of traffic signs is relatively complex taking into consideration the variations in letter sizes, colours, layouts etc. and thus lends itself to the use of a computer programme that can greatly simplify the task and aid standardisation of sign design. An appropriate sign design computer programme has been sourced from the internet at:

<http://www.buchanancomputing.net/Brochures/SignPlot>

According to the website *“SignPlot is the UK’s leading traffic sign software and includes state-of-the-art structural design. SignPlot is the only system to fully automate the layout and spacing rules of the Traffic Signs Regulations (TSRGD 2002) and UK Traffic Signs Manual. SignPlot makes sign design quick and accurate for both new and experienced designers”*.

It is therefore recommended that should the UK traffic sign design standard be adopted in Nigeria, suitable design software be sourced and implemented to promote standardization of design.

The Southern African Development Community Road Traffic Signs Manual (SADC RTSM) bases the layout and sizing of all guidance signs on the dimensional characteristics of the DIN 1451 Part 2 letter style. DIN uppercase letters have a height of "7d", where "d" is the stroke width of the letter. All arrows, symbols and fixed spaces on the sign face are specified as multiples of "d". In this way one sign face layout can serve as a design base for any size of letter.

Chapter 4 of Volume 1 of the Southern African Development Community Road Traffic Signs Manual (SADC RTSM)(Department of Transport, South Africa, May 2012) provides guidelines for the design of various types or information signs including elevated and ground mounted signs.

The choice of letter size is governed by a number of factors including:

- the sign mounting position, i.e. ground - or side -mounted, or overhead mounted
- the letter style used on the sign face
- legibility factor
- the visual acuity of drivers
- the luminance of the sign face
- whether the text will be displayed in the normal arrangement of upper and lowercase letters, or in uppercase letters only
- the speed of traffic on the approach to the sign(s)
- the amount of information displayed on the sign
- the horizontal and/or vertical displacement of the sign from the direction of movement of vehicles.

Section 4.4 of Chapter 4 of the manual provides the technical methodology for the selection of the letter sizes for various classes of road and operating speeds. The recommended letter sizes, for “average” conditions, are shown in Table 5.9:

Table 5.9: Recommended (Average) Letter Sizes – Rural Roads

Road Class		Operating Speed							
		120 km/hr		100 km/hr		80 km/hr		60 km/hr	
		Elev	Grnd	Elev	Grnd	Elev	Grnd	Elev	Grnd
A and B	Expressway	490/350	350/250	-	-	-	-	-	-
C	Arterial	-	280/200	420/300	280/200	350/200	210/150	-	-
D	Collector	-	280/200	-	280/200	-	210/150	-	-
E	Local	-	-	-	280/200	-	210/150	-	-

490/350 = Uppercase/Lowercase

Elevated (Elev) / Ground (Grnd) refers to the location of the sign

Source: (Department of Transport, South Africa, May 2012)

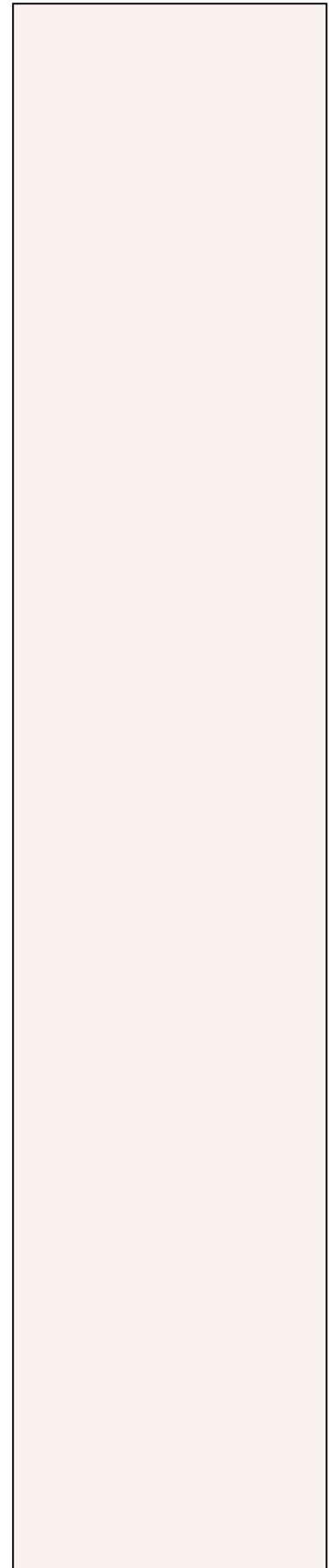

Table 5.10: Recommended (Average) Letter Sizes – Urban Roads

Road Class		Operating Speed							
		120 km/hr		100 km/hr		80 km/hr		60 km/hr	
		Elev	Grnd	Elev	Grnd	Elev	Grnd	Elev	Grnd
A and B	Expressway	-	-	350/250	350/250	350/250	350/250	-	-
C	Arterial	-	-	-	-	350/200	280/200	280/200	210/150
D	Collector	-	-	-	-	-	280/200	210/150	-
E	Local	-	-	-	-	-	-	-	175/125

490/350 = Uppercase/Lowercase

Elevated (Elev) / Ground (Grnd) refers to the location of the sign

Source:(Department of Transport, South Africa, May 2012)

The design of traffic signs is relatively complex taking into consideration the variations in letter sizes, colours, layouts etc. and thus lends itself to the use of a computer programme that can greatly simplify the task and aid standardization of sign design. An appropriate sign design computer programme has been sourced from the internet at <http://trafsoft.com/> .

According to the website, “Road Signs Design Unlimited” is a software package specifically developed for the traffic engineering industry. RSDU offers the user a simple and comprehensive

platform to design road signs. The software has the following features:

- Conforms to SADC guidelines
- Exports to HTML, PDF, DXF and WMF
- Prints in colour or vector wire frame
- All standard SADC symbols included
- Ability to use colour in symbols
- Uses XML for easy integration
- Can be used on local area network (LAN)
- Several templates to choose from
- Road sign design unlimited is compatible with all versions of Microsoft Windows

The above software package is in use by several manufacturers in South Africa and is extremely user friendly. The package is suited to the application of the signs included in the SADC Road Traffic Signs Manual. Although it is based on left hand side driving, it is possible that the software can be modified to right hand side driving. It is therefore recommended that this software be investigated for possible application in Nigeria for the design of standard road sign faces in line with the standards included in the SADC Road Traffic Signs Manual.

The road signs shown in the following diagrams were designed using Trafsoft software and illustrate the versatility of the product.

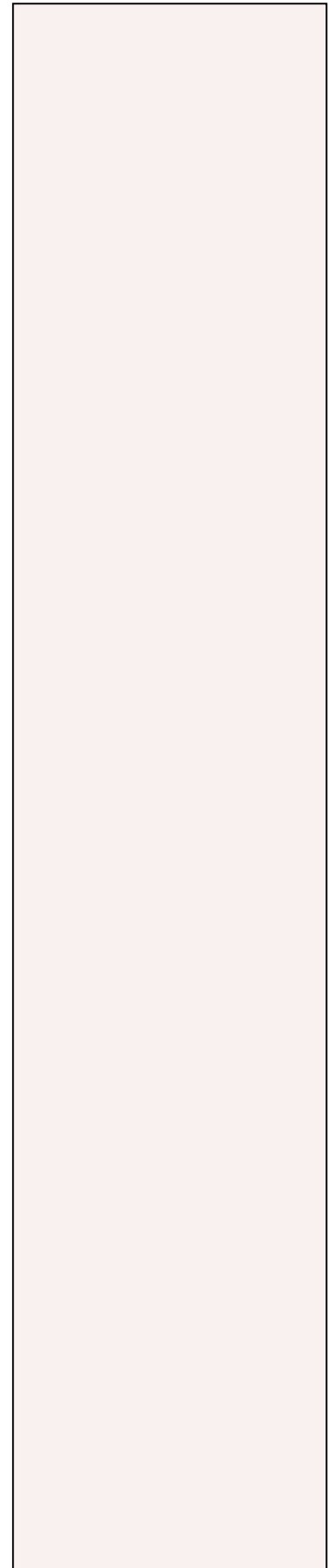



Figure 5.16: Typical Information Sign Designs using Trafsoft

5.5 Typical Applications at Intersections

The following diagrams indicate the typical road signage layouts at road intersections. Typical layouts at urban, rural and signalized intersections are shown.

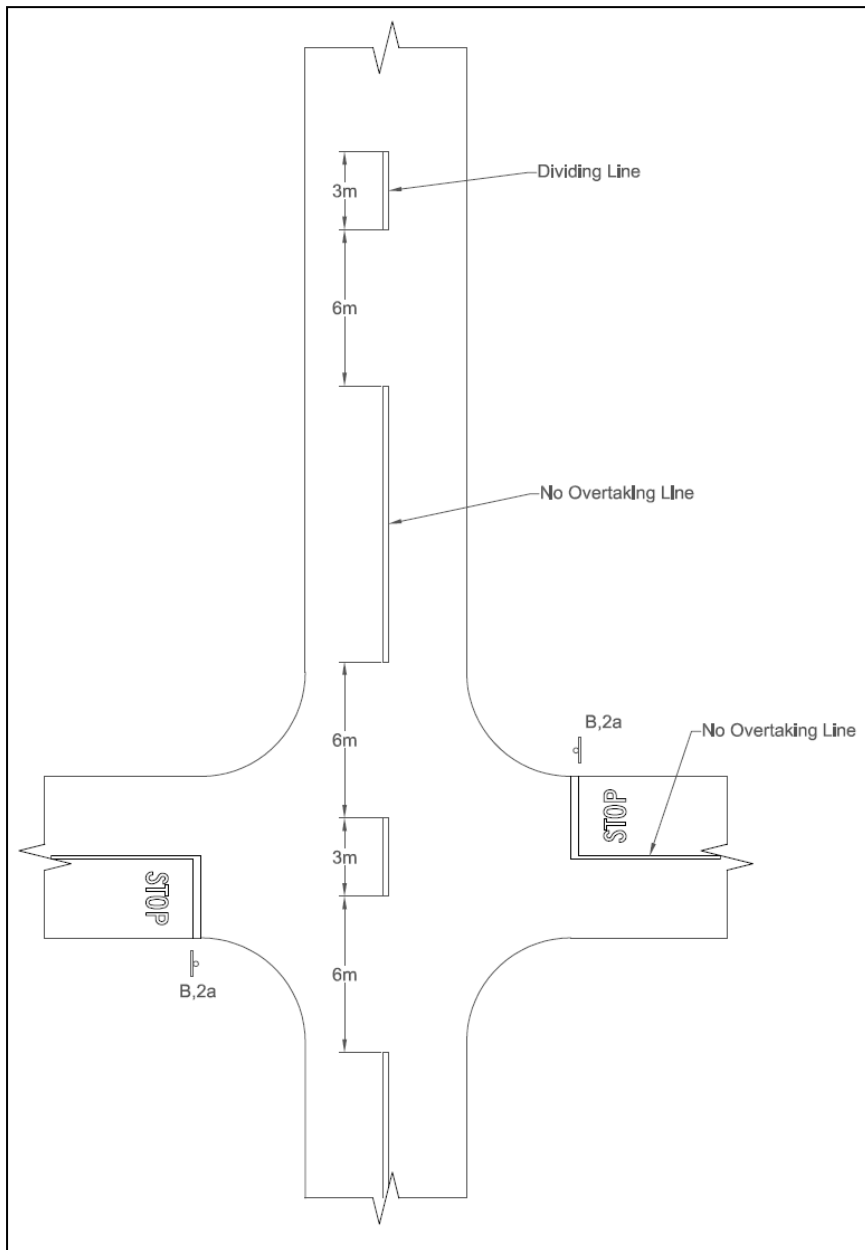
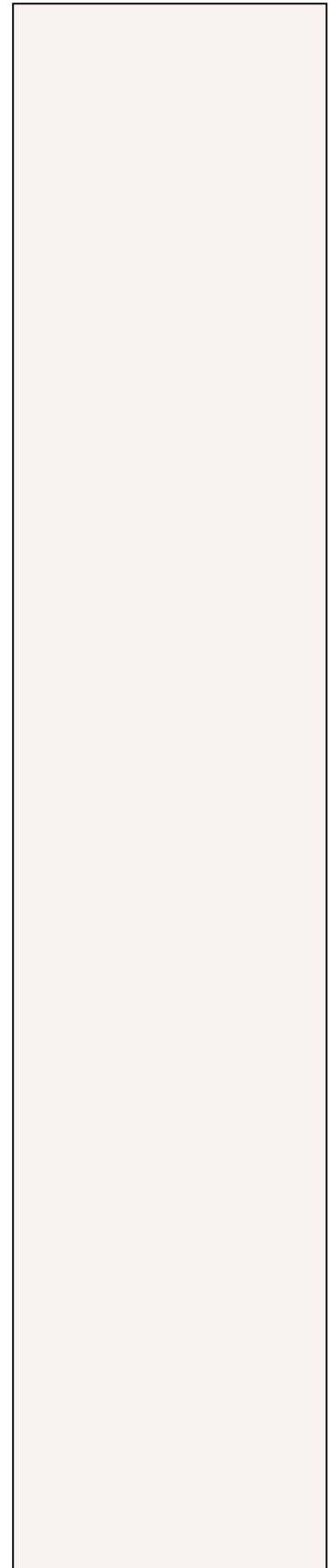

Figure 5.17: Minor Crossroad Junction



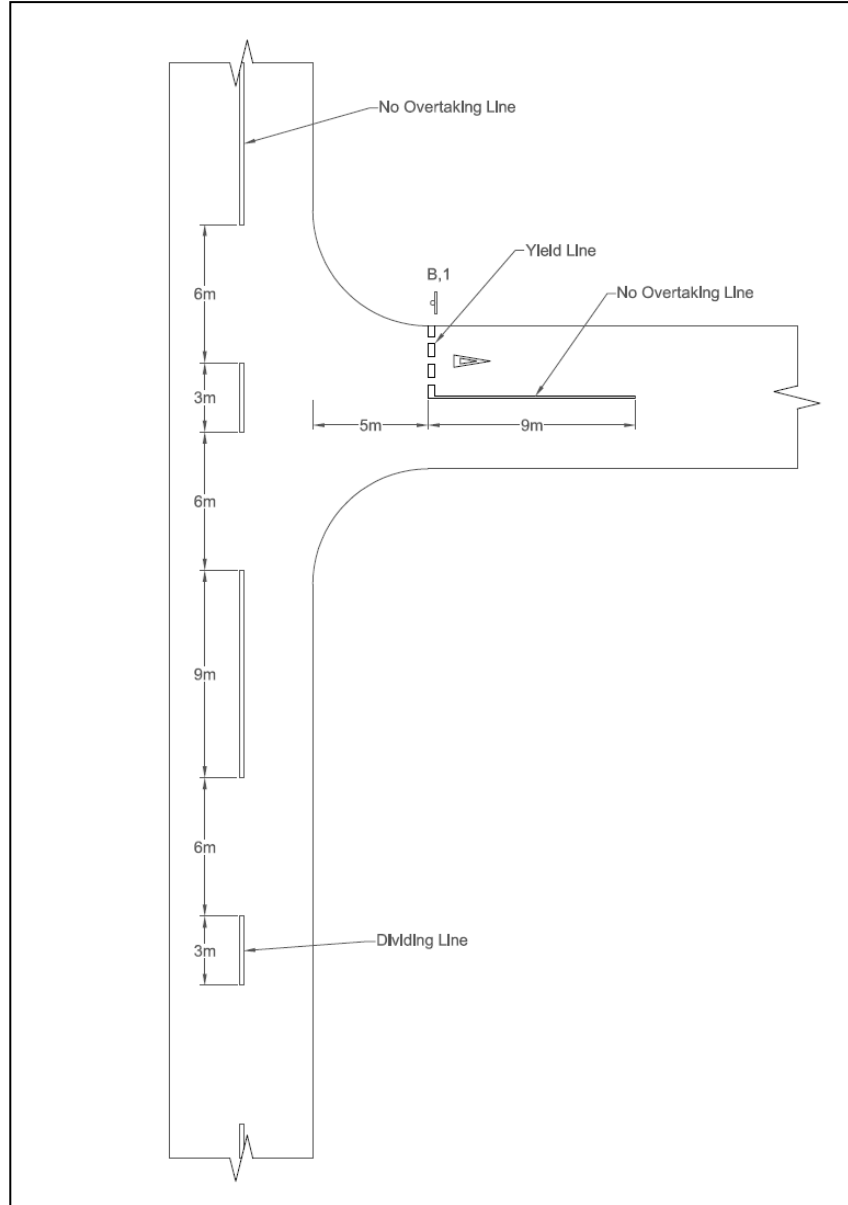
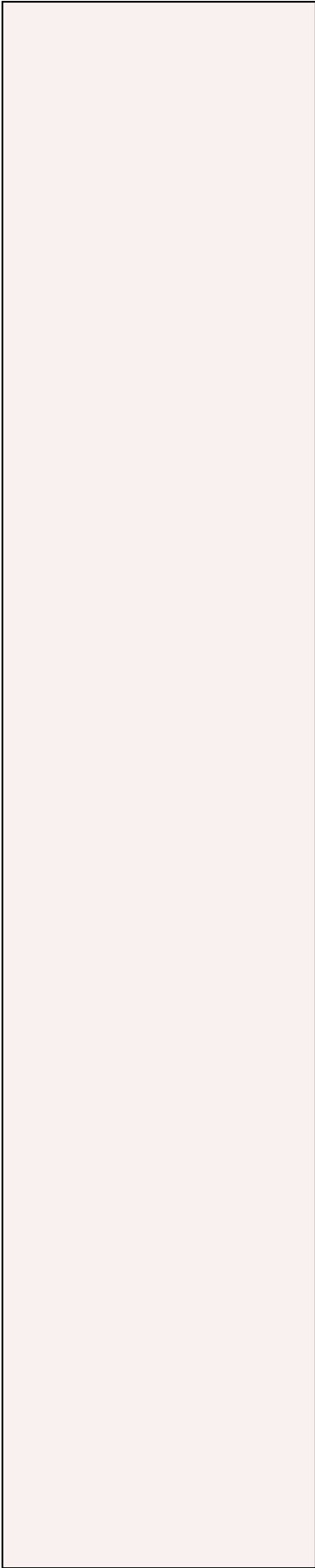

Figure 5.18: Minor T-Junction

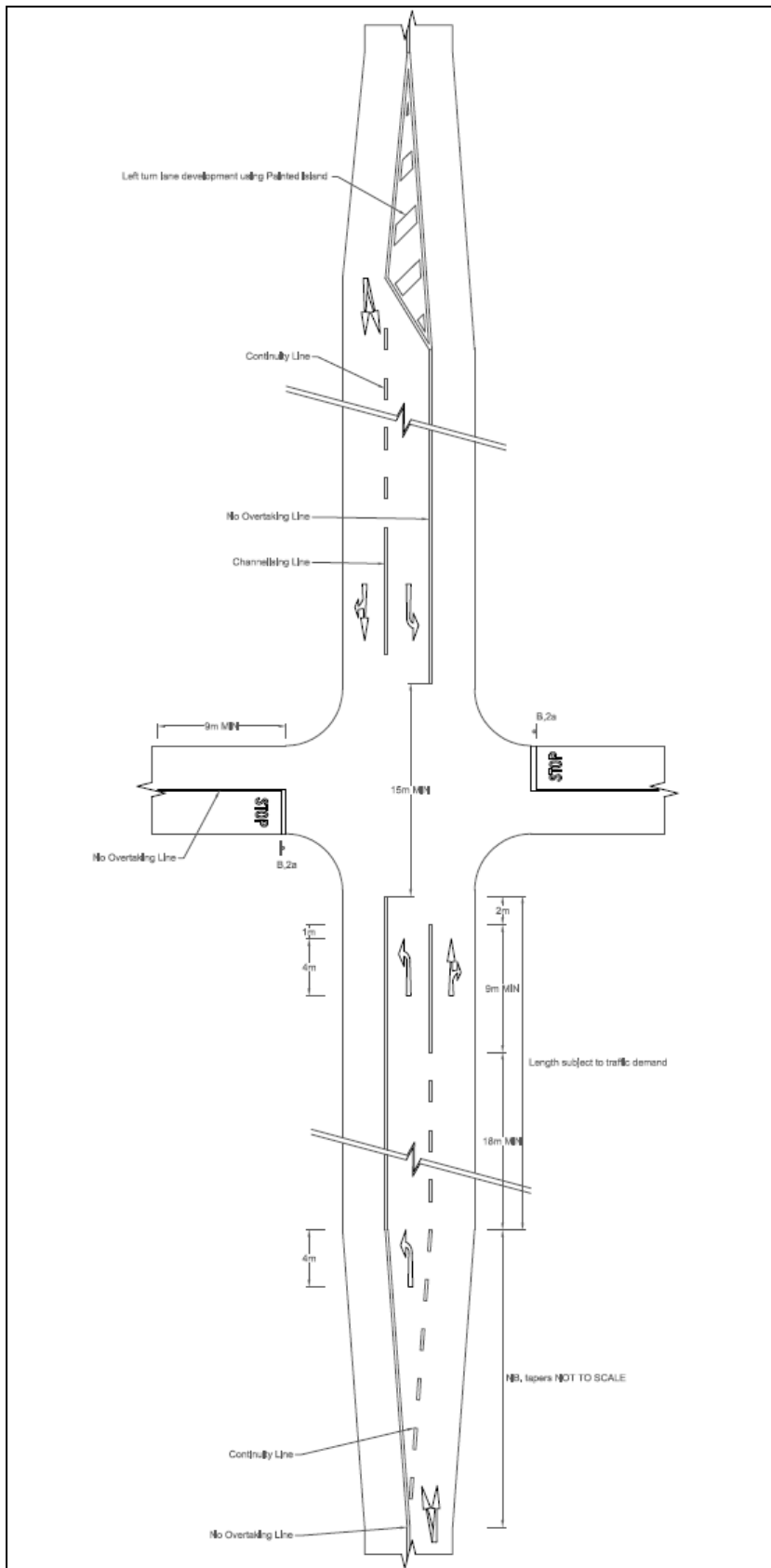
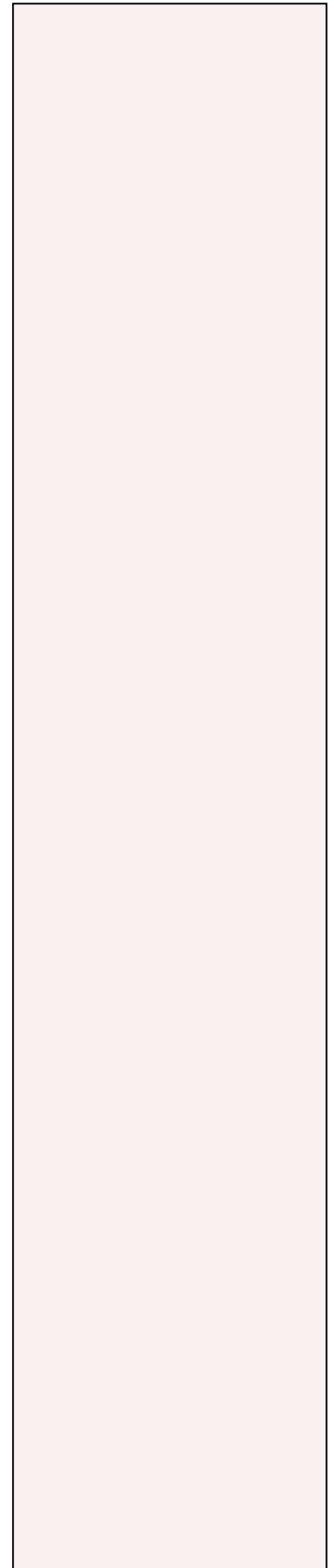

Figure 5.19: Cross Road Junction with Left Turn Lanes



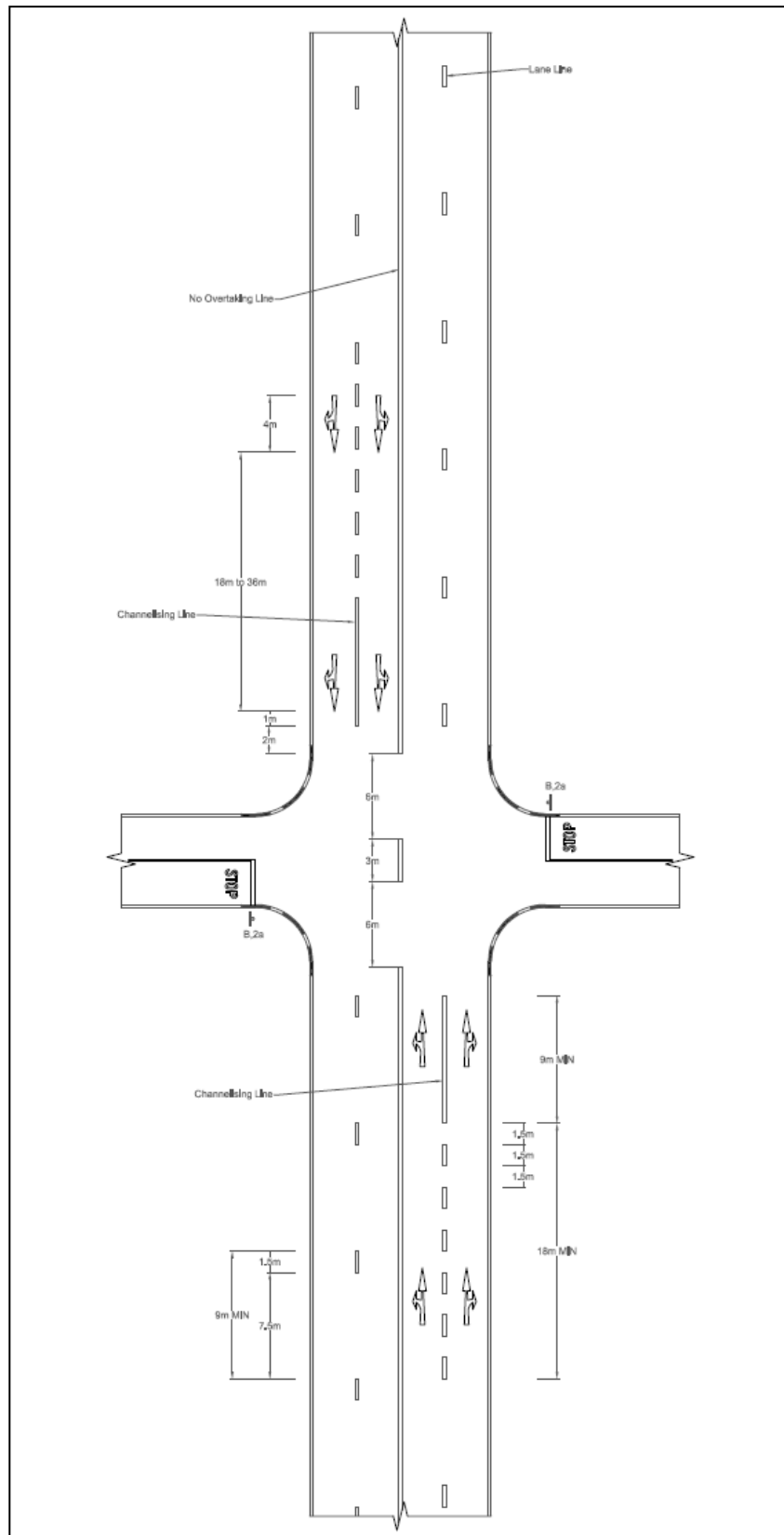

Figure 5.20: Crossroad Junction with 4-Lane Major Road

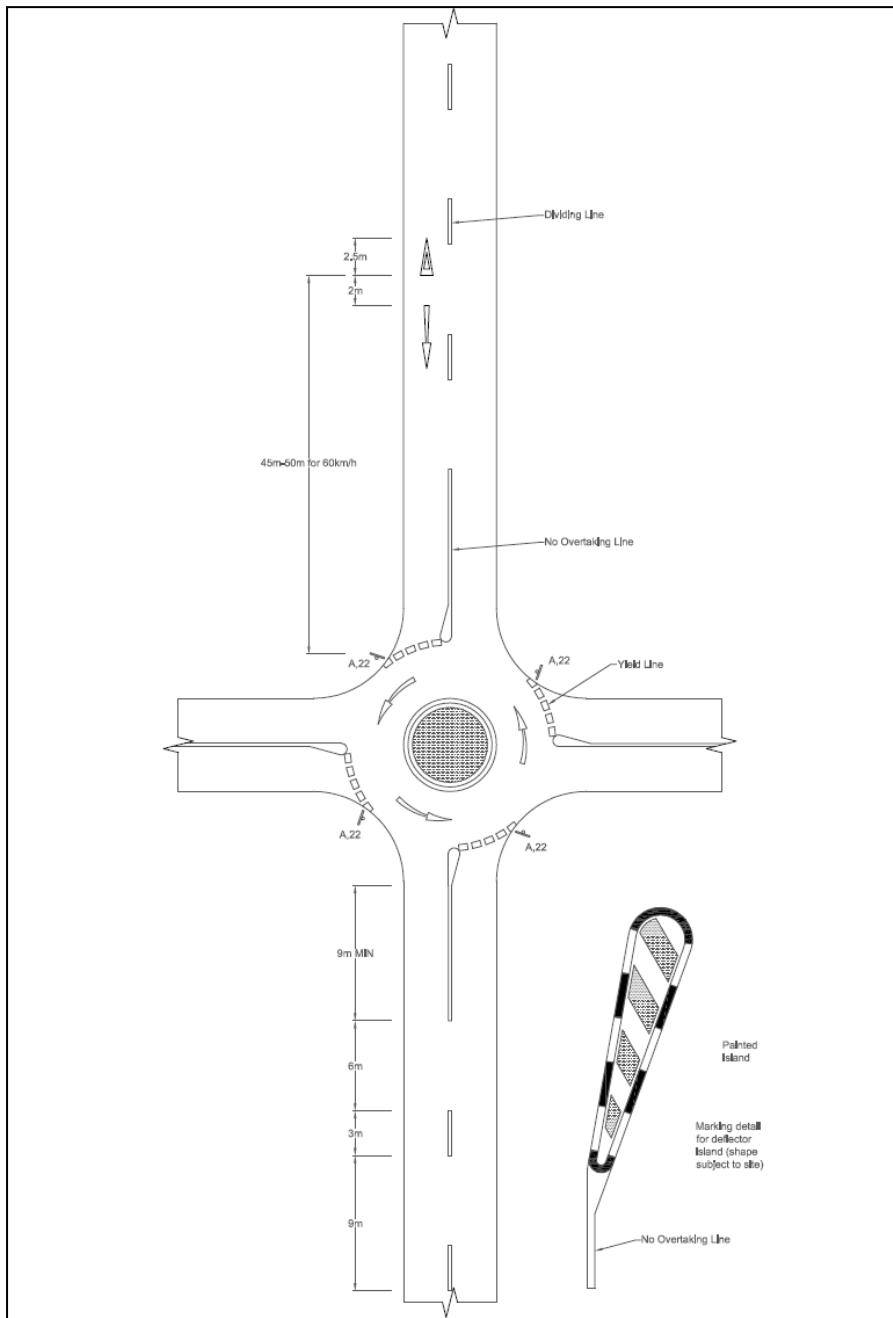
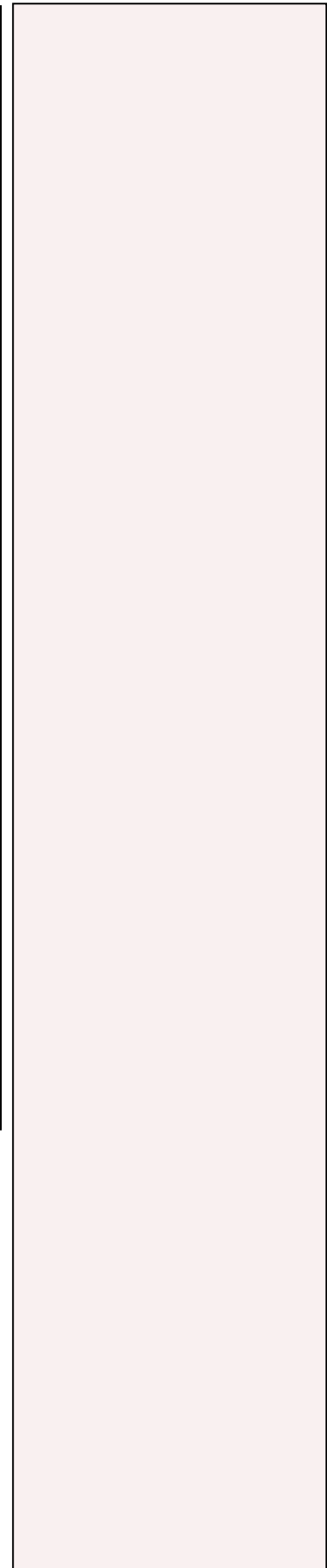

Figure 5.21: Traffic Circle



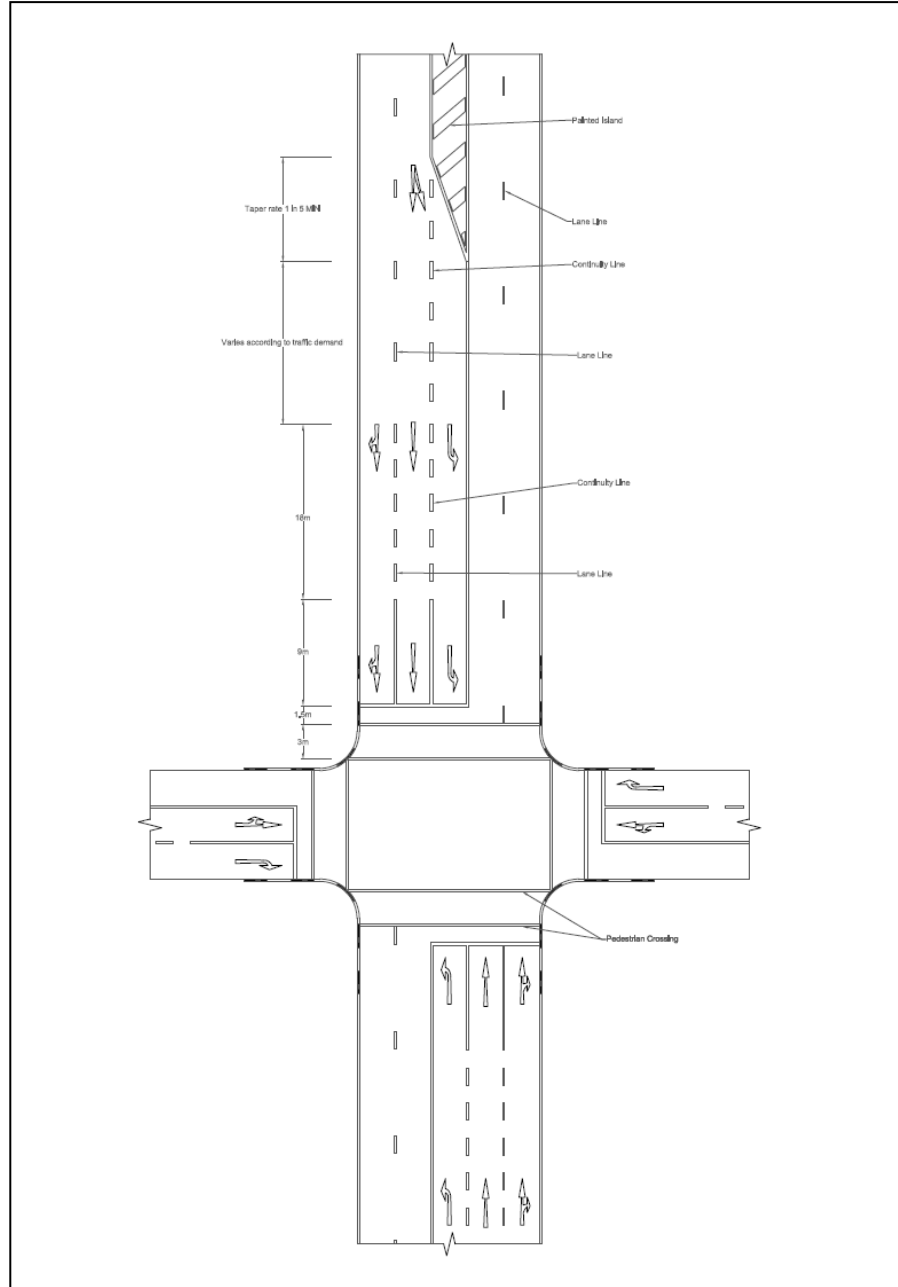
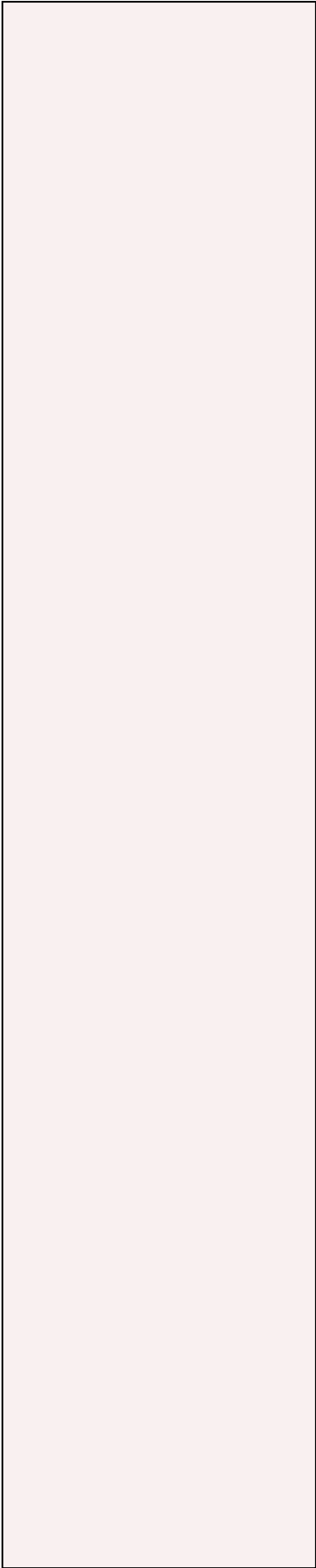

Figure 5.22: Signalized Multi Lane Road

5.6 Checklist for Road Design - Traffic Signs and Markings Drawings

The following checklist can be used when checking road design drawings for the correct application of road signs and markings. The check list is not exhaustive and is meant to highlight areas that may require further attention in the design process. It is thus meant as a guide. If further technical detail is required, then the relevant chapters of this manual should be referred to.

Table 5.11: Signs and Markings Check List

Traffic Signs, Traffic Signals and Road Markings Check List		Check Box
Regulatory Signs	Have adequate Regulatory (Prohibitory) signs been provided at intersections e.g. Stop, Give Way, – No-entry?	
	Have adequate Regulatory (Prohibitory) signs been provided to restrict vehicle mass and width where these may be required?	
	Have adequate Regulatory (Prohibitory) signs been provided to restrict turning movements at intersections should this be required?	
	Have adequate Regulatory (Prohibitory) signs been provided to prohibit overtaking where this may be required e.g. on narrow or gravel roads.	
	Have adequate Regulatory (Prohibitory) signs been provided to provide notice of the maximum or minimum speed limit?	
	Have adequate Regulatory (Prohibitory) signs been provided to prohibit or control parking or stopping?	
	Are any other special Regulatory signs necessary e.g. Customs?	
	Have adequate Regulatory (Mandatory) signs been provided to indicate the direction to be followed e.g. at an intersection?	
	Have adequate Regulatory (Mandatory) signs been provided to indicate one way or two way traffic, or the beginning of a divided road?	
	Have adequate Regulatory (Mandatory) signs been provided to indicate which side of an obstacle traffic should pass e.g. at a median island?	
	Have adequate Regulatory (Mandatory) signs been provided to advise of a traffic circle?	
	Have adequate Regulatory (Mandatory) signs been provided to indicate a compulsory footpath or cycle track?	
	Have adequate Regulatory (Mandatory) signs been provided to advise of a compulsory minimum speed	

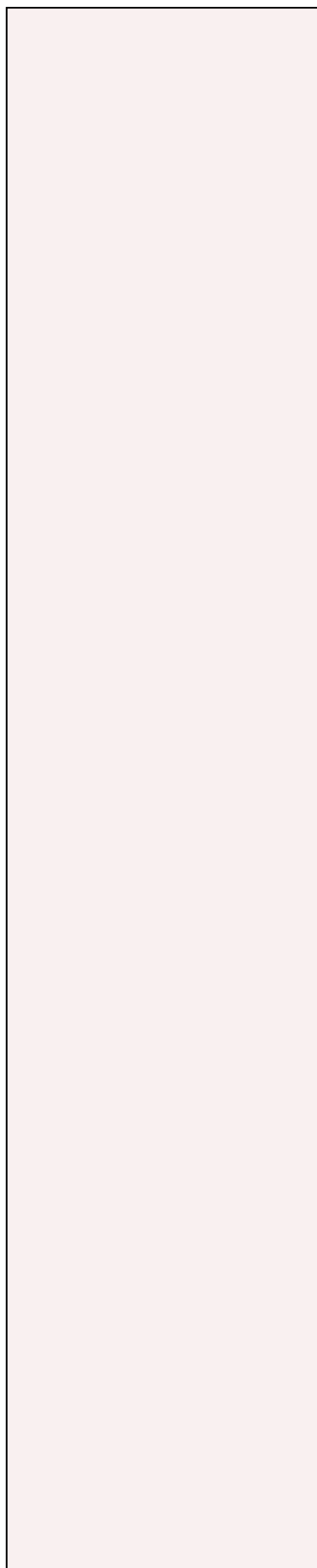

Traffic Signs, Traffic Signals and Road Markings Check List		Check Box
	limit e.g. on an expressway	
	Have adequate Regulatory (Mandatory) signs been provided to advise of a priority to oncoming traffic lane e.g. at a narrow road?	
Warning Signs	Have adequate Warning signs been provided to advise of sharp curves or dangerous bends?	
Information signs	Have adequate Warning signs been provided to advise of steep or dangerous ascents or descents e.g. a gradient of 10 to 15 percent?	
	Have adequate Warning signs been provided to advise of a narrow carriageway e.g. a narrow bridge or narrowing road?	
	Have adequate Warning signs been provided to advise of special conditions e.g. uneven road (speed bumps), slippery road or loose gravel?	
	Have adequate Warning signs been provided to advise of pedestrians, children or animals crossing the road or a marked pedestrian crossing?	
	Have adequate Warning signs been provided to advise of crossroads, T or skew junctions?	
	Have adequate Warning signs been provided to advise of intersections with major or minor roads?	
	Have adequate Warning signs been provided to advise of a roundabout ahead?	
	Have adequate Warning signs been provided to advise of a level crossing ahead?	
	Have adequate Warning signs been provided to advise of a Give Way or Yield control at an intersection?	
	Have adequate Warning signs been provided to advise of any special circumstances e.g. a Ferry terminal?	
	Have adequate Information signs been provided to advise place or street names?	
	Have adequate Information signs been provided for special facilities e.g. a hospital, first aid, filling station etc?	
	Have adequate Information signs been provided to advise where parking is authorized?	
	Have adequate Information signs been provided in advance of an intersection or interchange to advise of the destination?	
	Have adequate Information signs been provided to provide direction to minor facilities e.g. airport, towns, rest areas?	
	Have adequate count down signs been provided at expressway exits?	
Road Markings	Have adequate Regulatory Road Markings been provided to indicate Stop or yield control at intersections?	
	Have adequate Regulatory Road Markings been provided to designate pedestrian crossings?	
	Have adequate Regulatory Road Markings been	

Traffic Signs, Traffic Signals and Road Markings Check List		Check Box
	provided to indicate No Overtaking at places where there is inadequate sight distance e.g. a hill crest?	
	Have adequate Regulatory Road Markings been provided to indicate no Crossing or to Channelize traffic e.g. at junctions?	
	Have adequate Regulatory Road Markings been provided to indicate painted islands?	
	Have adequate Regulatory Road Markings been provided to indicate left or right shoulders?	
	Have adequate Regulatory Road Markings been provided to designate parking bays?	
	Have adequate Regulatory Road Markings been provided for painted arrows to indicate the direction of travel in a particular lane?	
	Have adequate Regulatory Road Markings been provided to designate exclusive lanes e.g. a bus lane?	
	Have adequate Warning Road Markings been provided to indicate the centreline of a road?	
	Have adequate Warning Road Markings been provided to indicate a yield control ahead.	
	Have adequate Guidance Road Markings been provided to indicate traffic lanes?	
	Have adequate Guidance Road Markings been provided to indicate Continuity e.g. where a lane deviates in a direction?	
	Have adequate Guidance Road Markings been provided to guide motorists at a junction?	
	Have adequate Guidance Road Markings been provided to advise motorists in the form of words e.g. the word STOP?	
Other Delineation Devices	Have road studs been provided to guide motorists where there is poor visibility e.g. misty areas, sharp curves	
	Have reflective devices been provided for Guardrails or Crash barriers provided at dangerous locations?	
Traffic Signals	Has a scale drawing of the intersection to be signalized showing the road layout and traffic lanes been provided?	
	The number, type and location of the traffic signal faces	
	Have pedestrian and cyclist facilities been provided?	
	Have traffic signal phasing, timing plans and offsets (to achieve synchronization of traffic signals at consecutive intersections) been provided?	
	Is the signature of approval of a competent, suitably qualified person been provided?	

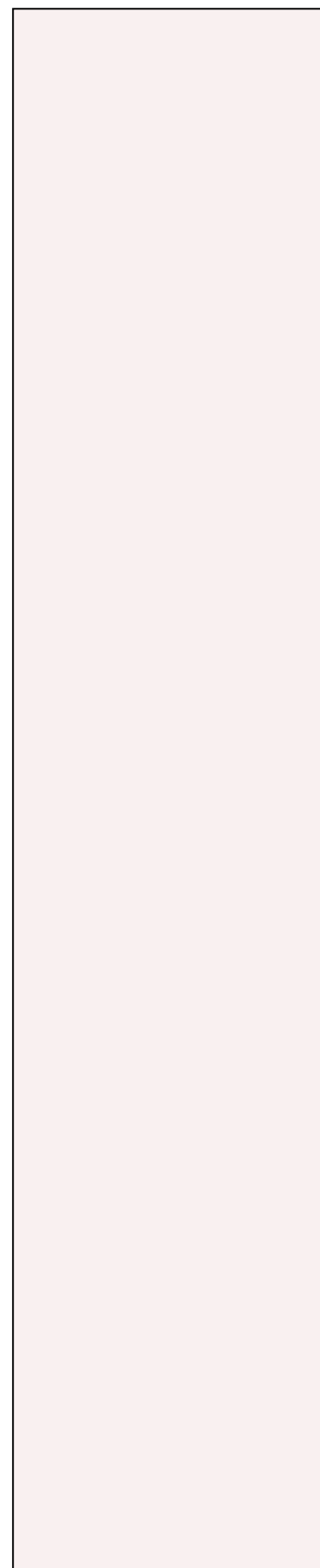

6 Materials and Installation

6.1 Traffic Sign Materials

Traffic signs should generally be retro-reflective to aid visibility at night and in poor weather conditions. This is particularly true for the message on the signs and in some cases the background of the sign as well: although cost may be a factor. Retro-reflective materials are available in many grades and quality. In the Southern African Development Community Road Traffic Signs Manual (Department of Transport, South Africa, May 2012), Classes I, II or III materials are specified according to the South African National Standard SANS 1519. The British Standard No 873, *The Construction of Road Traffic Signs and Internally Illuminated Bollards* may also be referenced in this regard. The Classes I, II or III have an increasing coefficient of retro-reflection.

According to SANS “Retro-reflective sheeting consists of a smooth , flat, transparent or translucent film that has retro-reflective elements below the surface forming an optical reflecting system that has a non exposed lens”. This can be achieved by incorporating glass beads or prisms.

It is recommended that all signs be retro-reflective except as follows:

- Prohibitory regulatory signs – black symbols may be “black semi-matt”
- Mandatory regulatory signs - the white arrows can be “white semi-matt”

Direction signs on expressways should have a higher reflectivity e.g. Class II or III due to the higher speeds.

The sign board material (metal sheeting) is specified at the discretion of the road authority. If the sign is to be fully coated with retro-reflective materials, then the material should have a life

expectancy of at least the same as the retro-reflective material (normally seven to 10 years).

Typically an epoxy coated galvanized steel sheeting can be used which is pre-painted and baked, resulting in a flat, durable, vinyl receptive surface that has UV resistant properties.

In areas where theft of large direction signs (usually information signs) is a problem, the signs can be manufactured in panels, as opposed to one large sheet. The panels can be affixed separately. This discourages the signs from being used for the construction of informal houses for example. Another example is to perforate the signs with drill holes. This renders the sheeting useless for any other use.

6.2 Road Marking Materials

Road markings are defined as markings applied to the road surface and can be in the form of paint, plastic or sheet.

The application and life of a road marking is markedly affected by the texture of the road surface and how it is prepared. Paints may be applied in a range of thicknesses and are quick drying. The thickness depends on the amount of traffic and the required durability (between 0.2 and 0.5 millimetres thick). Generally paints can be either suitable for spray application or for general brush application. They can also be supplied as suitable for the subsequent application of glass beads to improve reflectivity. The glass beads must be applied before the paint dries and are applied not less than 0.34 kg/m² of marking.

Markings in the form of a sheet or tape that is glued to the road surface can be used. Due to the cost their application is usually limited to small areas or to pre-formed symbols e.g. a STOP marking.

Factors that can be included in a specification for road marking include:

- Colour
- Luminance factor
- Coefficient of reflection
- Skid resistance

The durability of new markings is affected by the time a new road surface has had to “cure” and the application rate used for the road marking material. Usually the curing time for a new road surface is catered for by using two applications of the road markings at closely spaced applications.

6.3 Installation of Road Signs

There are a number of factors that affect the design of a support structure needed for a traffic sign. These include the following:

- Weather and climate e.g. wind, rain
- The location e.g. urban, rural
- Road class, speed
- Road side conditions e.g. cut, fill slopes
- Clearances – vertical and lateral
- Safety
- Vandalism

Regulatory and warning signs are considered to be small signs. These signs are normally ground mounted on a single pole. This can either be a free standing pole or an existing pole e.g. a light pole. The signs may require horizontal stiffening in the form of two horizontal struts at the back. Larger signs may require two supports depending on wind conditions.

Small Information signs (1.5 to 8m²) normally require two or three supports without diagonal bracing. These signs require back plate and framing to improve stiffness. This additional weight and wind loads must be planned for.

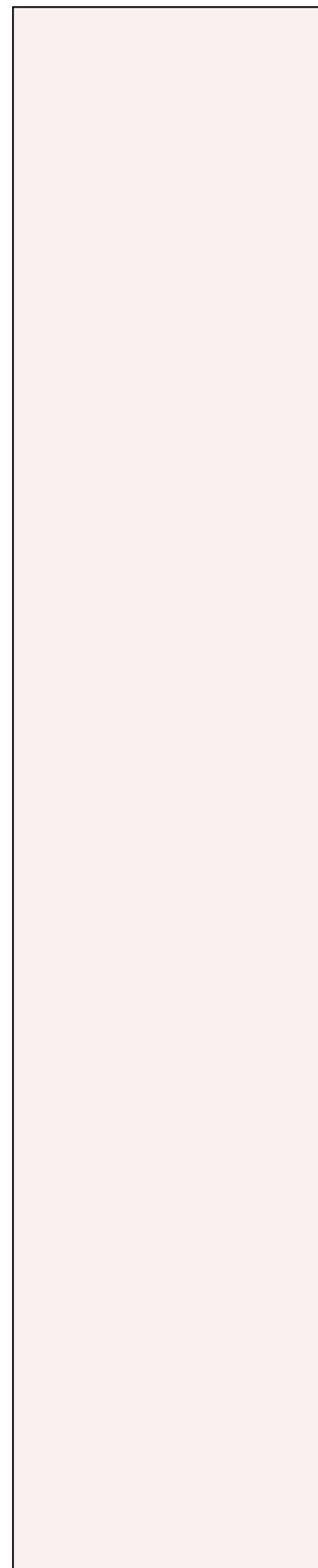

Large ground mounted information signs (8.0 to over 20m²) and these normally require three or four supporting poles with diagonal bracing. These signs require a back plate and extensive framing support. Due to the additional weight these signs require more extensive foundations and fastening brackets.

The above signs could also be erected on overhead structures on roads carrying higher volumes of traffic with more than two lanes per direction, and where higher visibility or lane specific messages are required. The support structures for these signs require an extensive back plate, framing and reinforced concrete foundations. The support structures may comprise simple to heavy portal structures, cantilever structures or existing bridges.

Supporting structures for signs range from timber poles, steel tubes, rolled sections or special fabricated supports. For the larger overhead structures a special structural design may be required and in other applications a standard support structure design may be used.

The design of sign support structures should take into consideration the following:

- a. *Loadings including the effect of wind, live and impact loads in excess of the structures dead load:*

Signs should be designed to resist vibration in the wind that can lead to metal fatigue. Live loads should be considered e.g. walkways on large structures, and the effects of a vehicle impact. Signs located close to the carriageway should be designed to be yielding or of a breakaway design in order to reduce the damage and injury in a vehicle crash e.g. allow the vehicle to pass over the sign or underneath the sign.

- b. *Ability to withstand vandalism:*

Vandalism of signs can be a significant factor in some areas and includes defacement of signs, gunshots, spray paint, stickers or posters and theft. These can have serious consequences (e.g. the theft of a speed limit sign) and should be corrected as soon as possible. Some measures to combat vandalism include:

- Use of easily replaceable materials for signs and supports e.g. wooden poles
- Use of vandalism resistant fasteners e.g. fasteners using Allen keys, hexagonal nuts, rivets
- Use of anchor rods, cleats or locking pins to prevent the removal of the sign from its supports
- Installation of signs high enough to be out of reach
- The placement of signs the maximum distance away from the carriageway
- Use of concrete filled metal tubes and stiffeners to prevent the bending of signs
- Use of a warning sticker on the back of the sign indicating that it is a criminal offence to interfere with a sign.

Table 6.1 indicates some typical support structures for signs. It is however a requirement that all support structures must receive approval from a registered Structural Engineer before erection.

Table 6.1: Example Supporting Structure for Signs

Sign Position	Support Structure	Support Size	Wall Thickness	Foundation Material
Ground mounted, - small signs	Single support timber post or steel tube.	76mm dia.	3mm max.	Natural ground
Ground mounted,- larger signs	Single support steel tube	76mm dia.	3mm – 3.5mm	Mass concrete
Ground mounted,- large signs	Single support steel tube	150mm dia.	5mm	Reinforced concrete
Ground mounted	Multiple support, (two to four) braced or not	Timber - 100mm dia. or Steel pipe - 76mm dia.	2mm – 3.5mm	Mass concrete
Overhead mounted – single cantilever	Tube or other profile	>150mm	>6mm	Reinforced concrete
Overhead mounted – gantry with two	Heavy tube or box section	>150mm	>6mm	Reinforced concrete

legs				
------	--	--	--	--

Signs may also be erected on reinforced, precast concrete posts or reinforced concrete structure as specified by a Structural Engineer. The use of light weight reinforced concrete slabs for a sign face has also been proposed in Nigeria to combat vandalism. Additional research is required into this proposal for a final design to be selected.

7 Bibliography

Commission, F. R. (2008). *Nigeria Highway Code*. Abuja: Detailwoks.

Corps, F. R. (2012). *Nigeria Road Safety Strategy*. Abuja.

Department of Transport, South Africa. (May 2012). *SADC Road Traffic Signs Manual - Digitised Version*.

Institute, T. T. (March 2008). *Traffic Signal Warrants - Guidelines for conduction a traffic signal warrant analysis*.

Open-Street-Map. (n.d.). http://wiki.openstreetmap.org/wiki/WikiProject_Nigeria.

UK-Department-of-Transport. (2004). *Traffic Signs Manual*.

United-Nations. (2006). *Convention on Road Signs*.

Wikipedia. (n.d.). *Wikipedia*. Retrieved from <http://en.wikipedia.org/>.